

**INTRODUCTION**

In view of the recent amendment made in the Designs (Amendment) Rules, 2008 with effect from 17/06/2008, Publication of the matter relating to Designs is being published in the Official Journal of The Patent Office. This Journal is being published on weekly basis on every Friday covering the various proceedings on Designs as required according to the provisions of under Rule 22, 25, 27 and 39 of the Design (Amendment) Rules, 2008. All the enquiries on this Official Journal and other information as required by the public should be addressed to the Controller General of Patents, Designs & Trade Marks. Suggestions and comments are requested from all quarters so that the content can be enriched.

## **COPYRIGHT PUBLICATION**

<b>Sr No</b>	<b>REGISTERED DESIGN NUMBERS</b>	<b>RENEWED ON</b>
1	250074	28-04-2023
2	250075	28-04-2023
3	250076	28-04-2023
4	248695	28-04-2023
5	250077	28-04-2023
6	252195	28-04-2023
7	243535	28-04-2023
8	252158	28-04-2023
9	254549	01-05-2023
10	252716	02-05-2023
11	256841	02-05-2023
12	260039	02-05-2023
13	256839	02-05-2023
14	251231	02-05-2023
15	255935	02-05-2023
16	252264	02-05-2023
17	235816	02-05-2023
18	329960-001	02-05-2023
19	329388-001	02-05-2023
20	241505	03-05-2023
21	244361	03-05-2023
22	242779	03-05-2023
23	232445	03-05-2023

**CANCELLATION PROCEEDINGS**  
**Under Section 19 of the Designs Act, 2000 &**  
**under Rule 29 of Designs Rules, 2001 (As Amended)**

**DECISION**

1

The Deputy Controller of Patents & Designs by his order dated 10/04/2023 dismissed the petition for cancellation filed by ARS STEELS AND ALLOY INTERNATIONAL PRIVATE LIMITED, an Indian company of D-109, 2<sup>nd</sup> Floor, LBR complex, Anna Nagar East, Chennai-600102 in respect of the registration of Design No.257980 dated 06/11/2013 under class 25-01 titled as 'CONSTRUCTION ROD' in the name of SUNVIK STEELS PVT.LTD, an Indian company of address #23, 4<sup>th</sup> Floor, MES Road, Bahubali Nagar, Jalahalli Village, Bangalore-560013.

2

The Deputy Controller of Patents & Designs by his order dated 12/04/2023 in respect of petition for cancellation filed by MR.KALPESH MANUBHAI RAMOLIYA having principal place of business at Survey no.31, Plot No.58, B/H, Hotel Krishna Park, Near Falcon Pumps Pvt.Ltd, Gondal Road, Vavdi-Rajkot, Gujarat cancelled the registration of registered Design No. 233559 dated 27/12/2010 under class 23-04 titled as 'AIR COOLER' in the name of MR.PARESH AJITKUMAR KAPOOR of Kapoor's building, Ashapura Road, Jamnagar-361001, Gujarat.

3

The Deputy Controller of Patents & Designs by his order dated 13/04/2023 in respect of petition for cancellation filed by MR.PARESH AJITKUMAR KAPOOR of Kapoor's building, Ashapura Road, Jamnagar-361001, Gujarat cancelled the registration of registered Design No. 314930-001 dated 18/02/2019 under class 23-04 titled as 'AIR COOLER' in the name of MR.KALPESH MANUBHAI RAMOLIYA having principal place of business at Survey no.31, Plot No.58, B/H, Hotel Krishna Park, Near Falcon Pumps Pvt.Ltd, Gondal Road, Vavdi-Rajkot, Gujarat.

4

The Deputy Controller of Patents & Designs by his order dated 13/04/2023 in respect of petition for cancellation filed by MR.PARESH AJITKUMAR KAPOOR of Kapoor's building, Ashapura Road, Jamnagar-361001, Gujarat cancelled the registration of registered Design No. 314930-002 dated 18/02/2019 under class 23-04 titled as 'AIR COOLER' in the name of MR.KALPESH MANUBHAI RAMOLIYA having principal place of business at Survey no.31, Plot No.58, B/H, Hotel Krishna Park, Near Falcon Pumps Pvt.Ltd, Gondal Road, Vavdi-Rajkot, Gujarat

5

The Deputy Controller of Patents & Designs by his order dated 28/03/2023 in respect of petition for cancellation filed by HINDUSTAN UNILEVER LTD, a company incorporated under the Indian Companies Act having registered office at Unilever House, B.D.Sawant Marg, Chakala, Andheri(East), Mumbai-400099 cancelled the registration of registered Design No.279662 dated 21/01/2016 under class 23-01 titled as 'CARTRIDGE FOR WATER FILTER' in the name of T.VINOOD, resident of D.No.29-3-26/1, Venkateswara Rao Street, Governorpet, Vijayawada(AP).

## REGISTRATION OF DESIGNS

The following designs have been registered. They are now open for public inspection. In the following each entry the Date of Registration is shown. The Priority Number, Priority Date and Priority Country are also shown

Design Number	362202-001	
Class	07-02	
<b>JAYSON INDUSTRIES S-109, Badli Industrial Area, Phase-1, Delhi-110043</b>		
Date of Registration	08/04/2022	
Title	CONTAINER	
Priority NA		
Design Number	349723-001	
Class	13-03	
<b>MAXCEL PLAST 133, Shree Ram Industrial Estate, Odhav, Near Sonis Chawl Cross Road, Ahmedabad - 382415, Gujarat , India</b>		
Date of Registration	18/09/2021	
Title	POINT BOX (ELECTRICITY)	
Priority NA		
Design Number	377704-001	
Class	23-99	
<b>1. Dr. Siva Sangari M Associate Professor, Department of Computer Science and Engineering, KPR Institute of Engineering and Technology Arsur, Coimbatore, Tamil Nadu, India-641407 2. Ms. Buvani Sankari V, III CSE Associate Professor, Department of Computer Science and Engineering, KPR Institute of Engineering and Technology Arsur, Coimbatore, Tamil Nadu, India-641407 3. Ms. Hasha K Associate Professor, Department of Computer Science and Engineering, KPR Institute of Engineering and Technology Arsur, Coimbatore, Tamil Nadu, India-641407 4. Ms. Amrit Candida M Associate Professor, Department of Computer Science and Engineering, KPR Institute of Engineering and Technology Arsur, Coimbatore, Tamil Nadu, India-641407 , et al.</b>		
Date of Registration	20/01/2023	
Title	RECHARGEABLE AND PORTABLE SANITARY PAD DISPOSABLE MACHINE	
Priority NA		

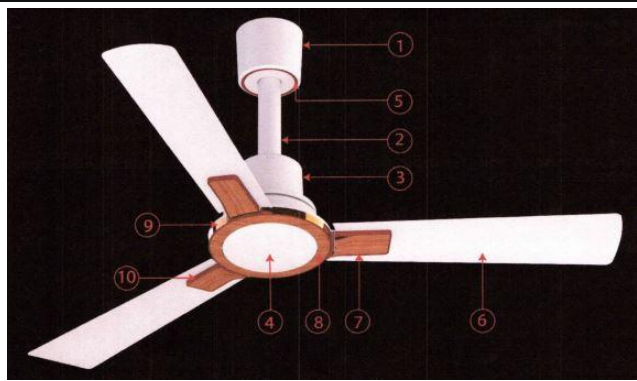
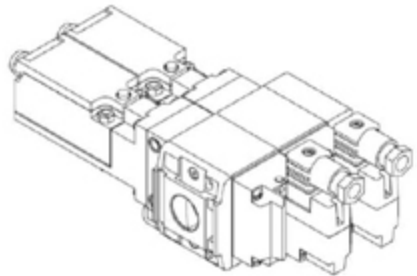
<b>Design Number</b>	359827-001		
<b>Class</b>	02-02		
<b>Harpreet Narula Kabbalah, C-66, Sector-4, Noida- 201301, Uttar Pradesh, INDIA</b>			
<b>Date of Registration</b>	03/03/2022		
<b>Title</b>	Garment Set		
<b>Priority NA</b>			
<b>Design Number</b>	365283-001		
<b>Class</b>	23-04		
<b>M/s V-Guard Industries Ltd 42/962, Vennala High School Road, Vennala, Kochi - 682028, Kerala</b>			
<b>Date of Registration</b>	02/06/2022		
<b>Title</b>	Ceiling Fan		
<b>Priority NA</b>			
<b>Design Number</b>	340157-001		
<b>Class</b>	23-01		
<b>SMC CORPORATION 14-1, Sotokanda 4-chome, Chiyoda-ku, Tokyo, 101-0021 Japan.</b>			
<b>Date of Registration</b>	04/03/2021		
<b>Title</b>	ELECTROMAGNETIC VALVE		
<b>Priority</b>			
Priority Number	Date	Country	
202030523169.1	07/09/2020	China	

<b>Design Number</b>	338535-001	
<b>Class</b>	13-03	
<b>DANFOSS POWER ELECTRONICS A/S Ulsnæs 1 DK-6300 Gråsten Denmark</b>		
<b>Date of Registration</b>	03/02/2021	
<b>Title</b>	FREQUENCY CONVERTER	
<b>Priority</b>		
Priority Number	Date	Country
008073407-0011	04/08/2020	EUIPO



<b>Design Number</b>	378622-001
<b>Class</b>	23-01
<b>UNIFLOW CONTROLS PRIVATE LIMITED Q 49/149, JAI MATA DI COMPOUND, THANE- BHIWANDI AGRA ROAD, KALHER VILLAGE, BHIWANDI, DIST. THANE-421302, MAHARASHTRA, INDIA.</b>	
<b>Date of Registration</b>	03/02/2023
<b>Title</b>	BELLOW SEALED GLOBE CONTROL VALVE
<b>Priority NA</b>	

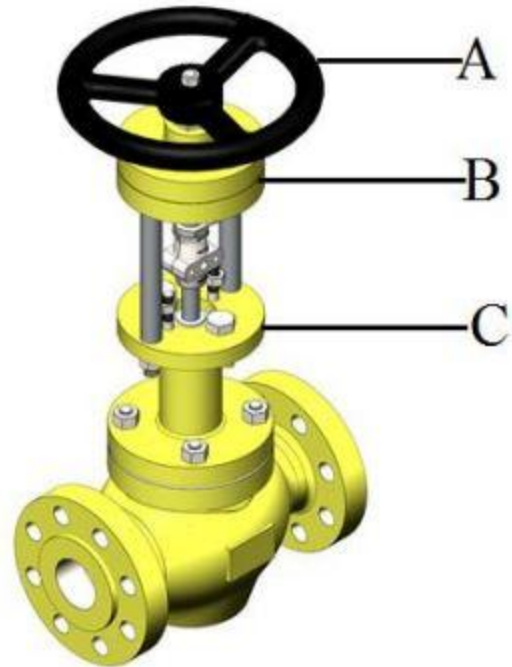

<b>Design Number</b>	356437-001	
<b>Class</b>	12-07	
<b>Joint Stock Company "Aviation Holding Company "Sukhoi" 23 b, Polikarpova str., Moscow 125284 Russia</b>		
<b>Date of Registration</b>	10/01/2022	
<b>Title</b>	AIRCRAFT	
<b>Priority</b>		
Priority Number	Date	Country
2021503627	19/07/2021	Russia

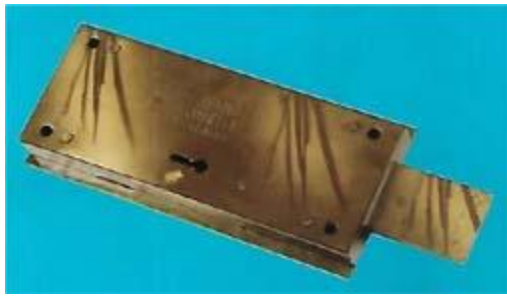

Design Number	358443-001	
Class	08-07	
Arvind Kumar Aditya Trading as M/s Rekha Metal Works of 1/297, Chhawani, Aligarh-202001 (U.P.) (India)		
Date of Registration	12/02/2022	
Title	SHUTTER LOCK	
Priority NA		

Design Number	377505-001
Class	23-08
Kishan Steel Tech Virani Aghat, 5-Ghanshyam Industrial Area, Dhebar Road, Nr. Rajkamal Crossing, Rajkot-360 002, Gujarat - (India), Proprietor is Chandubhai Naranbhai Davra	
Date of Registration	16/01/2023
Title	SOAP DISH
Priority NA	



Design Number	379502-001
Class	13-03
V-Guard Industries Ltd 42/962, Vennala High School Road, Vennala, Kochi – 682028, Kerala State	
Date of Registration	16/02/2023
Title	Voltage Stabilizer
Priority NA	

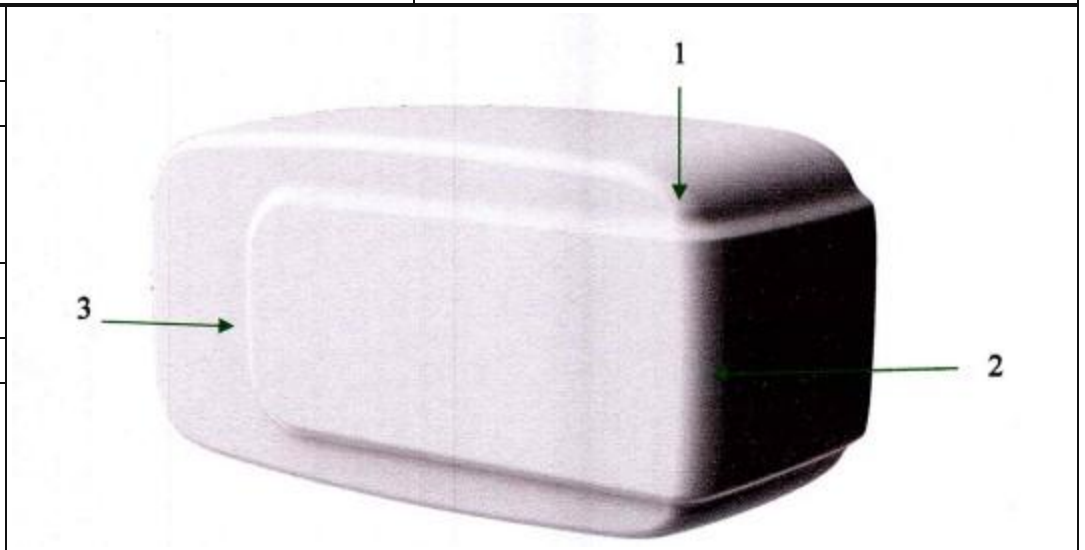

Design Number	379511-001	
Class	26-03	
<b>1.DR . PIYUSH RAJA ASSISTANT PROFESSOR, CSE, COLLEGE OF ENGINEERING ROORKEE, ROORKEE, UTTARAKHAND-247667 2. DR. V.KANNAN MANAGING DIRECTOR, CLDC RESEARCH AND DEVELOPMENT NO.997, METTUPALAYAM ROAD, NEAR X-CUT SIGNAL,R.S.PURAM, COIMBATORE, TAMIL NADU -641002. 3. DR. S.KALYAN ASSISTANT PROFESSOR OF MANAGEMENT STUDIES, DEPT. OF BASIC SCIENCES AND HUMANITIES -MANAGEMENT STUDIES, BVRIT HYDERABAD COLLEGE OF ENGINEERING FOR WOMEN, HYDERABAD, TELANGANA- 500090 4. DR.E.N.GANESH DEAN SCHOOL OF ENGINEERING , ECE, VELS INSTITUTE OF SCIENCE TECHNOLOGY ADVANCED STUDIES, CHENNAI, TAMILNADU-600044 , et al.</b>		
Date of Registration	16/02/2023	
Title	IOT ENABLED SOLAR STREET LIGHT SYSTEM	
Priority NA		
Design Number	349768-001	
Class	25-01	
<b>Siri Maharaja Granites Private Limited E-315A, Road No. 16, VKIA, Sikar Road - Jaipur - 302013, Rajasthan, India</b>		
Date of Registration	20/09/2021	
Title	Tiles	
Priority NA		
Design Number	378513-001	
Class	23-01	
<b>1. TEJASHREE TEJAS KULKARNI Flat no. 3, Malati Apartments, Girija Society, Kothrud, Pune - 411038, Maharashtra, India 2. PADMANABH SHEKHAR KULKARNI 401, Sindh Society, Baner Road, Aundh, Pune - 411007, Maharashtra, India.</b>		
Date of Registration	02/02/2023	
Title	Solenoid Valve for Refrigerants	
Priority NA		



<b>Design Number</b>	378256-001	
<b>Class</b>	12-08	
<b>1. HYUNDAI MOTOR COMPANY 12, Heolleung-ro, Seocho-gu, Seoul, 06797 Republic of Korea 2. KIA CORPORATION 12, Heolleung-ro, Seocho-gu, Seoul, 06797 Republic of Korea</b>		
<b>Date of Registration</b>	30/01/2023	
<b>Title</b>	AUTOMOBILE	
<b>Priority NA</b>		

<b>Design Number</b>	375198-014	
<b>Class</b>	11-01	
<b>Aulyra Design Private Limited 3rd floor, Plot No. 3807, Phase 4, Chakkarpur, Gurugram, Haryana – 122001</b>		
<b>Date of Registration</b>	07/12/2022	
<b>Title</b>	Ring	
<b>Priority NA</b>		

<b>Design Number</b>	375802-001	
<b>Class</b>	23-08	
<b>KISHAN STEEL TECH VIRANI AGHAT, 5-GHANSHYAM INDUSTRIAL AREA, DHEBAR ROAD, NR RAJKAMAL CROSSING, RAJKOT-360002, GUJARAT, INDIA</b>		
<b>Date of Registration</b>	19/12/2022	
<b>Title</b>	TUMBLER WITH SOAP DISH	
<b>Priority NA</b>		

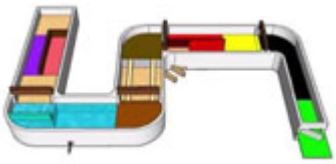
Design Number	357624-001	
Class	24-02	
<b>SIDHARTH MEHAN ISF COLLEGE OF PHARMACY, MOGA, PUNJAB</b>		
Date of Registration	31/01/2022	
Title	Maze for evaluation of neurobehavioral and neuromuscular activities in rodents for Laboratory	
<b>Priority NA</b>		

Design Number	379372-001
Class	10-04
<p>1. Prof. (Dr.) Vishal Garg Principal &amp; Professor, Jaipur School of Pharmacy, Maharaj Vinayak Global University, Dhand Tehsil Amer Jaipur Delhi NH 11 C, Jaipur, Rajasthan - 302020</p> <p>2. Mr. Arman Dalal B. Pharm, M. Pharm, Akalgarh, Budha Khera lather, Julana, Jind, Haryana, India - 126101</p> <p>3. Mr. Sandeep Balasaheb Jagatp Manager, Ross Lifesciences Ltd, Pune, Maharashtra, India - 411026</p> <p>4. Dr. K. S. Kokilambigai Associate Professor, Department of Pharmaceutical Analysis, SRM College of Pharmacy, SRM Institute of Science and Technology, Kattankulathur, Chengalpattu, Tamil Nadu, India - 603203 , et al.</p>	
Date of Registration	15/02/2023
Title	Liquid chromatography mass spectrometer
<b>Priority NA</b>	

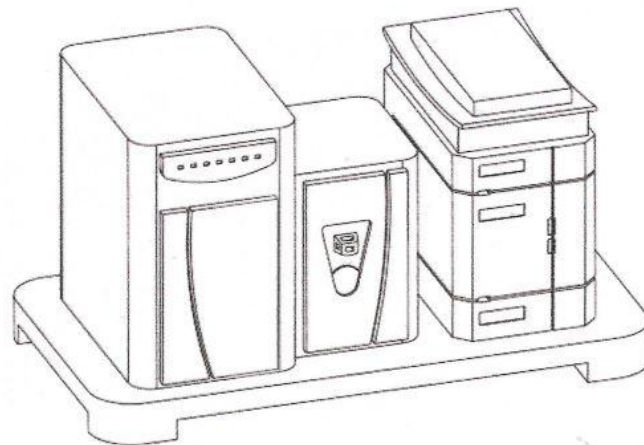

Design Number	354957-001	
Class	09-03	
<b>ELC MANAGEMENT LLC 155 Pinelawn Road, Suite 345 South, Melville, NY 11747, USA.</b>		
Date of Registration	15/12/2021	
Title	MODULAR PALETTE	
<b>Priority</b>		
Priority Number	Date	Country
29/795,059	16/06/2021	U.S.A.







<b>Design Number</b>	378471-001	
<b>Class</b>	12-09	
<b>TRACTORS AND FARM EQUIPMENT LIMITED No. 861, Anna salai, Chennai – 600002, Tamil Nadu, India</b>		
<b>Date of Registration</b>	02/02/2023	
<b>Title</b>	TRACTOR	
<b>Priority NA</b>		

<b>Design Number</b>	376023-002	
<b>Class</b>	21-01	
<b>Mandeep Singh Chhabra Plot no. 19, Sector A, Amrit Palace Colony, Nipania, Indore-452010 Madhya Pradesh</b>		
<b>Date of Registration</b>	23/12/2022	
<b>Title</b>	Cute Dollhouse Set	
<b>Priority NA</b>		

<b>Design Number</b>	377364-003	
<b>Class</b>	23-04	
<b>M/S Eeco Cool Home Appliances House No. 56, Shani Gate, Maliwara, Ghaziabad, Uttarpradesh-201001, India, Partners are Pradeep Kumar, Manjeet Singh</b>		
<b>Date of Registration</b>	13/01/2023	
<b>Title</b>	COOLER GRILL	
<b>Priority NA</b>		

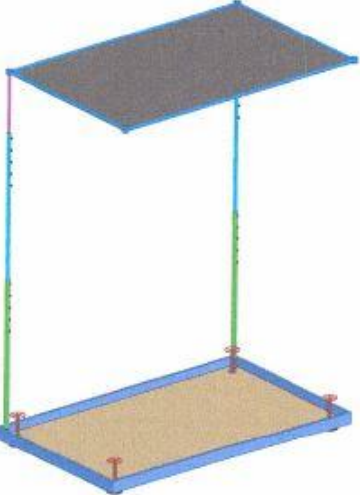
Design Number	365790-001	
Class	23-04	
<b>M/s. NEXA ELECTRICALS Plot No- A-3/11, IDA, Kukatpally, Gandhinagar Extn., Hyderabad- 500037.</b>		
Date of Registration	09/06/2022	
Title	FAN	
Priority NA		
Design Number	377661-001	
Class	13-03	
<b>Pritiben Kiritkumar Nagda Harsh Metal Plot No. 6, GIDC, Shankar Tekri, Udyognagar, Jamnagar, Gujarat, India</b>		
Date of Registration	19/01/2023	
Title	ELECTRIC SWITCHES PIN SOCKET	
Priority NA		
Design Number	379133-001	
Class	24-01	
<b>1.DR. JAYANT SUBHASHCHANDRA BIDKAR PROFESSOR &amp; HOD (PHARMACOGNOSY), SGMSPM's SHARADCHANDRA PAWAR COLLEGE OF PHARMACY, DUMBARWADI, KHAMUNDI, JUNNAR, PUNE-410504, MAHARASHTRA, INDIA 2. MRS. SHITAL JAYANT BIDKAR ASSISTANT PROFESSOR (PHARMACEUTICS), SGMSPM's SHARADCHANDRA PAWAR COLLEGE OF PHARMACY, DUMBARWADI, KHAMUNDI, JUNNAR, PUNE-410504, MAHARASHTRA, INDIA 3. MR. ABHIJEET ASHOK BIDKAR ASSISTANT PROFESSOR &amp; HOD PHARMACOGNOSY STES SINHGAD INSTITUTE OF PHARMACY (ACCREDITED BY NAAC WITH GRADE B+) NARHE TOP TECHNICAL CAMPUS, INFRONT OF BANK OF MAHARASHTRA NARHE BRANCH, NARHE AMBEGAON ROAD, NARHE, PUNE- 411 041. 4. MS. PRANALI BABURAO DANGAT ASSISTANT PROFESSOR (PHARMACEUTICS), SGMSPM's SHARADCHANDRA PAWAR COLLEGE OF PHARMACY, DUMBARWADI, KHAMUNDI, JUNNAR, PUNE-410504, MAHARASHTRA, INDIA , et al.</b>		
Date of Registration	11/02/2023	
Title	PHARMACEUTICAL SOXHLET APPARATUS	
Priority NA		

<b>Design Number</b>	379574-001	
<b>Class</b>	21-01	
<b>1. Himanshu A. Deshmukh A/ 602 Gera Isle Royale, Bavdhan, Pune – 411021, Maharashtra, India 2. Harshal A. Deshmukh A/ 602 Gera Isle Royale, Bavdhan, Pune – 411021, Maharashtra, India 3. Suhasini Paul A-603, 43 Privet Drive, Balewadi, Pune – 411045, Maharashtra, India 4. Sandip Paul A-603, 43 Privet Drive, Balewadi, Pune – 411045, Maharashtra, India</b>		
<b>Date of Registration</b>	17/02/2023	
<b>Title</b>	TOY	
<b>Priority NA</b>		
<b>Design Number</b>	346004-001	
<b>Class</b>	12-07	
<b>Mouthik Kiran Reddy Dharasani 201, Jyothi Senate, Plot No 361, Road No 24, Jubilee Hills, Hyderabad, Telangana 500033</b>		
<b>Date of Registration</b>	09/07/2021	
<b>Title</b>	Autonomous Unmanned Aerial Vehicle	
<b>Priority NA</b>		
<b>Design Number</b>	376555-001	
<b>Class</b>	06-04	
<b>Dr. P. Jayakumar Research Faculty, Kalasalingam Academy of Research and Education, IRC – Kalasalingam Academy of Research and Education, Anand Nagar, Krishnankoil - 626 126, Srivilliputtur (via), Virudunagar District Tamilnadu, India</b>		
<b>Date of Registration</b>	02/01/2023	
<b>Title</b>	HEIGHT ADJUSTABLE VEGETABLE HOLDING TRAY FOR STREET VENDORS	
<b>Priority NA</b>		

Design Number	352753-001	
Class	13-03	
Light and Shade Electricals Private Limited 11 to 20 and 108 to 114, Luthria House, Sativali Road, Vasai East, District: Palghar, 401208, Maharashtra		
Date of Registration	08/11/2021	
Title	HOLDER	
Priority NA		

Design Number	364586-001
Class	12-01
1. Dr. Piyush Kumar Pareek Dr. Piyush Kumar Pareek Professor, Department of Computer Science & Engineering & Head of IPR Cell Nitte Meenakshi Institute of Technology, Bengaluru 2. Paramesh R Associate Professor, Department of CSE, Global Academy of Technology Bengaluru, Affiliated to VTU Belgaum Karnataka 3. Sameena H S Assistant Professor, Department of CSE, Global Academy of Technology, Bengaluru, Affiliated to VTU, Belgaum, Karnataka 4. Ramesh B N Head of the department, CSE, East West Institute of Polytechnic, Yelahanka New Town, Bangalore 560064, et al.	
Date of Registration	23/05/2022
Title	AI SMART SOLAR VEHICLE
Priority NA	

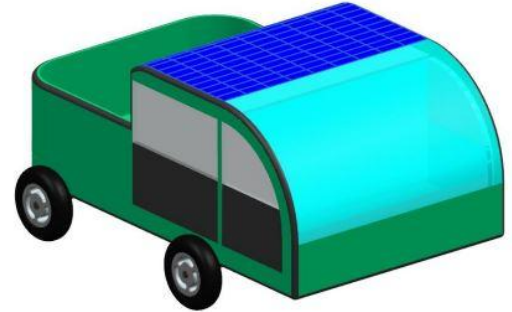



Design Number	328083-001	
Class	12-08	
TÜRKİYE'NİN OTOMOBİLİ GIRIŞIM GRUBU SANAYİ VE TİCARET A.S. Muallimkoy Mah. Deniz Cad. No:143/1 Gebze, KOCAELİ/TURKEY		
Date of Registration	11/03/2020	
Title	CAR	
Priority		
Priority Number	Date	Country
2019/05481	12/09/2019	Turkey

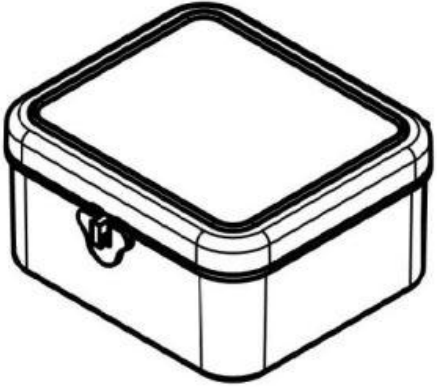

<b>Design Number</b>	378851-001	
<b>Class</b>	09-03	
<b>Mr. Ramesh Kumar V Jain Shop No.55, 3rd Galli, Kirtikar Market, Dr. D'Silva Road, Dadar West, Mumbai 400028, Maharashtra, India</b>		
<b>Date of Registration</b>	07/02/2023	
<b>Title</b>	BINDI BOX	
<b>Priority NA</b>		

<b>Design Number</b>	359248-001	
<b>Class</b>	31-00	
<b>Havells India Limited 904, 9th Floor, Surya Kiran Building, K G Marg, Connaught Place, New Delhi -110001</b>		
<b>Date of Registration</b>	24/02/2022	
<b>Title</b>	HAND MIXER	
<b>Priority NA</b>		

<b>Design Number</b>	376529-001	
<b>Class</b>	12-11	
<b>Nalin Mahajan M/s. Ravi Industries, Opposite Raja Vanaspati, G.T. Road, Dhandari Kalan, Ludhiana - 141010 (Punjab), India.</b>		
<b>Date of Registration</b>	02/01/2023	
<b>Title</b>	BICYCLE	
<b>Priority NA</b>		

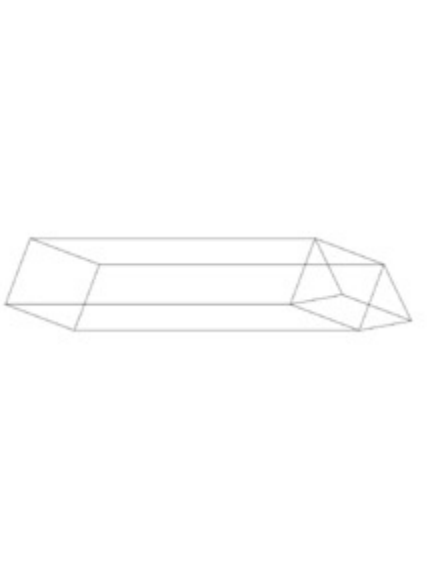
Design Number	378423-001	
Class	31-00	
V-Guard Industries Ltd 42/962, Vennala High School Road, Vennala, Kochi – 682028, Kerala State		
Date of Registration	01/02/2023	
Title	Base of Mixer Grinder	
Priority NA		
Design Number	376729-007	
Class	08-06	
M M Steel Industries 25 No, 1st Gate, Karuna Sagar Estate, Nr Nar Narayan Kanta, Anil Starch Mill Road, Naroda, Ahmedabad-382345, Gujarat, India, Proprietor is Ketankumar Mathurbhai Patel.		
Date of Registration	05/01/2023	
Title	DOOR HANDLE	
Priority NA		
Design Number	354247-001	
Class	16-06	
1. CHITKARA INNOVATION INCUBATOR FOUNDATION SCO: 160-161, SECTOR -9C, MADHYA MARG, CHANDIGARH- 160009, INDIA. 2. NEHA KUMRA ASSOCIATE PROFESSOR, CHITKARA UNIVERSITY, ATAL SHIKSHA KUNJ, PINJORE-NALAGARH NATIONAL HIGHWAY (NH-21A), DISTRICT: SOLAN - 174103, HIMACHAL PRADESH, INDIA. 3. RAJESH KUMAR LECTURER AND TRAINING AND PLACEMENT OFFICER, DEPARTMENT OF CIVIL ENGINEERING. MEHR CHAND POLYTECHNIC COLLEGE, JALANDHAR-144008(PUNJAB), INDIA. 4. SHEFALI BATRA ASSOCIATE PROFESSOR, CHITKARA UNIVERSITY, ATAL SHIKSHA KUNJ, PINJORE-NALAGARH NATIONAL HIGHWAY (NH-21A), DISTRICT: SOLAN - 174103, HIMACHAL PRADESH, INDIA. , et al.		
Date of Registration	03/12/2021	
Title	DEVICE TO REDIRECT SUN- RAYS	
Priority NA		

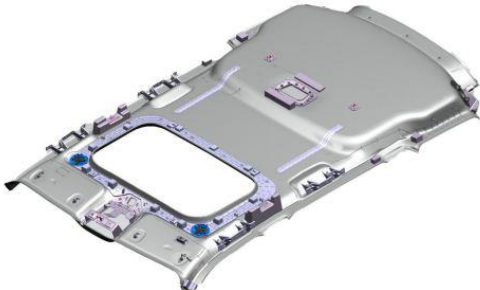

<b>Design Number</b>	379824-001	
<b>Class</b>	12-11	
<b>GOGOA1 MOTORS PRIVATE LIMITED PLOT NO. 35/36, SECTOR-2A, KOPAR KHAIRANE, NEAR MUNICIPAL SCHOOL PIN: 400709, Maharashtra, INDIA</b>		
<b>Date of Registration</b>	21/02/2023	
<b>Title</b>	Battery Bracket for Vehicles	
<b>Priority NA</b>		

<b>Design Number</b>	363840-001	
<b>Class</b>	12-16	
<b>MAHINDRA &amp; MAHINDRA LIMITED Mahindra Research Valley, Mahindra World City, Plot No.41/1, Anjur P.O., Chengalpattu, Kanchipuram District, Tamilnadu – 603004</b>		
<b>Date of Registration</b>	06/05/2022	
<b>Title</b>	Headliner for a vehicle	
<b>Priority NA</b>		

<b>Design Number</b>	363845-001	
<b>Class</b>	12-08	
<b>MAHINDRA &amp; MAHINDRA LIMITED Mahindra Research Valley, Mahindra World City, Plot No.41/1, Anjur P.O., Chengalpattu, Kanchipuram District, Tamilnadu – 603004</b>		
<b>Date of Registration</b>	06/05/2022	
<b>Title</b>	Vehicle	
<b>Priority NA</b>		

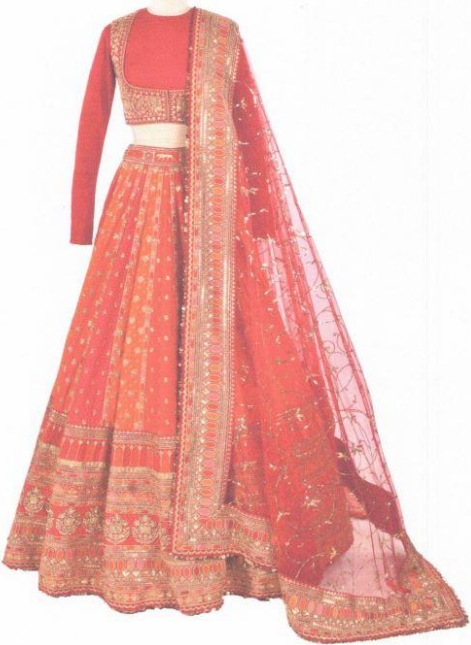
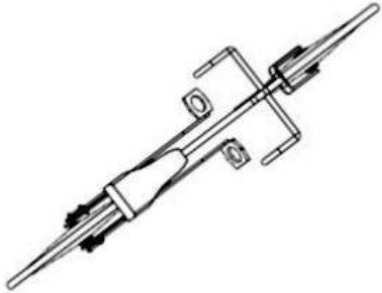
<b>Design Number</b>	344066-001		
<b>Class</b>	10-04		
<b>TERAHERTZ GROUP LTD. 60th Ramat Yam St. Herzliya 4685160 Israel</b>			
<b>Date of Registration</b>	31/05/2021		
<b>Title</b>	BREATH ANALYZER		
<b>Priority</b>			
<b>Priority Number</b>	<b>Date</b>	<b>Country</b>	
29/760,618	02/12/2020	U.S.A.	
<b>Priority NA</b>			
<b>Design Number</b>	380039-001		
<b>Class</b>	02-02		
<b>SABYASACHI CALCUTTA LLP 80/2 Topsia Road (South), Kolkata-700046, West Bengal.</b>			
<b>Date of Registration</b>	24/02/2023		
<b>Title</b>	LADIES GARMENT (SET)		
<b>Priority NA</b>			
<b>Design Number</b>	355719-001		
<b>Class</b>	12-11		
<b>Indian Institute of Technology Kanpur Dean, Research &amp; Development, Room Number 151, Faculty Building, Post Office: IIT Kanpur, Kanpur-208016, U.P, India</b>			
<b>Date of Registration</b>	29/12/2021		
<b>Title</b>	Chainless Bicycle		
<b>Priority NA</b>			

<b>Design Number</b>	346112-001	
<b>Class</b>	13-99	
<b>Latitude LLC Haceinda heights, CA, 95492, US</b>		
<b>Date of Registration</b>	10/07/2021	
<b>Title</b>	TRANSPARENT SOCKET BLOCK	
<b>Priority</b>		
Priority Number	Date	Country
29/766,133	13/01/2021	U.S.A.

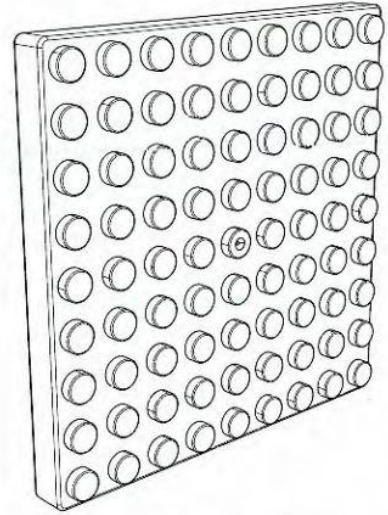

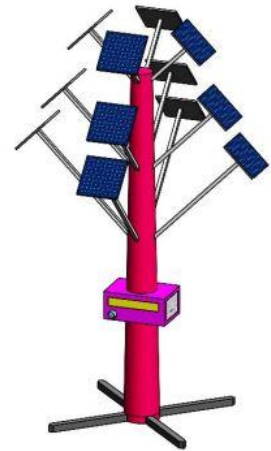

<b>Design Number</b>	379096-001	
<b>Class</b>	13-04	
<b>1. Dr. P. JOTHILAKSHMI Professor, Department of ECE, Sri Venkateswara College of Engineering Pennalur Village, Chennai - Bengaluru High Road, Sriperumbudur-602117, Kancheepuram Dist, Tamil Nadu, India. 2. Mr. V. POONCHEZHIAN Design Engineer, Coastal Rubber Equipment Pvt Ltd Ambattur, Chennai-600098, Tamil Nadu, India.</b>		
<b>Date of Registration</b>	11/02/2023	
<b>Title</b>	Portable solar tree	
<b>Priority NA</b>		



<b>Design Number</b>	339138-005	
<b>Class</b>	12-15	
<b>Apollo Tyres Ltd Global R &amp; D Centre - Asia, B-25, SIPCOT Industrial Growth Centre, Sriperumbudur Taluk, Kancheepuram, Tamil Nadu, 602105</b>		
<b>Date of Registration</b>	15/02/2021	
<b>Title</b>	TYRE FOR A VEHICLE WHEEL	
<b>Priority NA</b>		

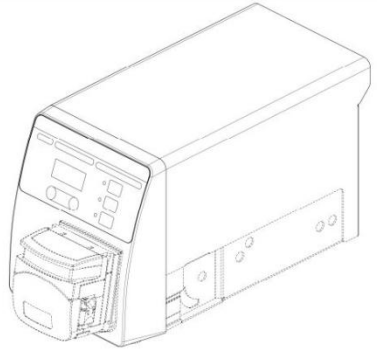

<b>Design Number</b>	376540-001		
<b>Class</b>	13-02		
<b>Dr. N. Karpagam Professor, Electrical and Electronic Engineering, Velammal College of Engineering &amp; Technology, Viraganoor, Madurai - 625009, India</b>			
<b>Date of Registration</b>	02/01/2023		
<b>Title</b>	SOLAR POWERED MOBILE PHONE CHARGER FOR TWO WHEELER		
<b>Priority NA</b>			
<b>Design Number</b>	379404-001		
<b>Class</b>	02-02		
<b>SABYASACHI CALCUTTA LLP 80/2 Topsia Road (South), Kolkata-700046, West Bengal.</b>			
<b>Date of Registration</b>	15/02/2023		
<b>Title</b>	LADIES GARMENT (SET)		
<b>Priority NA</b>			
<b>Design Number</b>	379689-001		
<b>Class</b>	12-11		
<b>HONDA MOTOR CO., LTD. 1-1, Minami-Aoyama 2-Chome, Minato-ku, Tokyo, 107-8556 Japan</b>			
<b>Date of Registration</b>	20/02/2023		
<b>Title</b>	MOTORCYCLE		
<b>Priority</b>			
<b>Priority Number</b>	<b>Date</b>	<b>Country</b>	
2022-018021	24/08/2022	Japan	

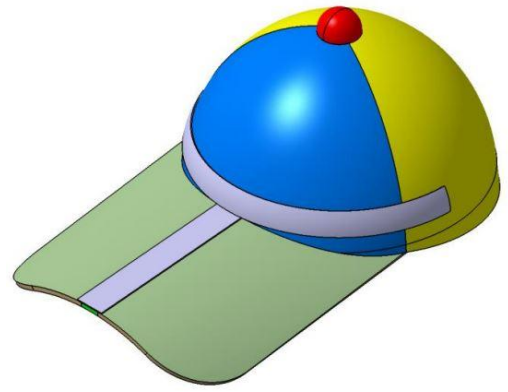
Design Number	361515-001	
Class	24-01	
<b>Keymed (Medical &amp; Industrial Equipment) Ltd. Keymed House, Stock Road, Southend-on-Sea, Essex SS2 5QH, United Kingdom</b>		
Date of Registration	30/03/2022	
Title	PUMP	
Priority NA		
Design Number	350622-001	
Class	14-02	
<b>1.K. Anbumani Associate Professor, Department of Electronics and Instrumentation Engineering, Sri Sairam Engineering college, Sai Leo Nagar, Tambaram West, Chennai - 600044</b> <b>2. Mrs. M. Sivaranjani Assistant Professor, Department of Civil Engineering, Sri Sairam Engineering College, West Tambaram, Chennai, Tamilnadu - 600044.</b> <b>3. Dr. T. Subha Associate Professor, Department of Information Technology, Sri Sairam Engineering College, West Tambaram, Chennai, Tamilnadu - 600044.</b> <b>4. M. C. Anand Chakaravarthi Assistant Professor, Department of Mechanical Engineering, Sri Sairam Engineering college, Sai Leo Nagar, Tambaram West, Chennai - 600044</b>		
Date of Registration	04/10/2021	
Title	“A STYLUS PEN”.	
Priority NA		
Design Number	379066-001	
Class	10-05	
<b>1.DR. SHRIRAM RAMESH PETHAKAR PROFESSOR &amp; PRINCIPAL, SSPM's SHRAMJIVI COLLEGE OF PHARMACY, OMERGA, DIST OSMANABAD - 413606, MAHARASHTRA, INDIA</b> <b>2. MRS. JYOTI BALAJI ARSUDE ASSISTANT PROFESSOR, SSPM's SHRAMJIVI COLLEGE OF PHARMACY, OMERGA, DIST OSMANABAD - 413606, MAHARASHTRA, INDIA</b> <b>3. MR. PRABHAT KUMAR DAS ASSOCIATE PROFESSOR &amp; HOD (PHARMACOLOGY), GRY INSTITUTE OF PHARMACY, VILL. BORAWAN, TEH. KASRAWAD, DIST. KHARGONE, MADHYA PRADESH-451228, INDIA</b> <b>4. MR. VIJAY SALVEKAR ASSOCIATE PROFESSOR (PHARMACOLOGY), GRY INSTITUTE OF PHARMACY, VILL. BORAWAN, TEH. KASRAWAD, DIST. KHARGONE, MADHYA PRADESH-451228, INDIA , et al.</b>		
Date of Registration	10/02/2023	
Title	ANXIETY DETECTION CAP	
Priority NA		

Design Number	377662-001	
Class	08-08	
<b>Rajesh Gopalbhai Pambhar Radha Mira Ind. Area, Street No. 2, National Highway 8/B, Nr. Shree Hari Ind. Area, Rajkot, Gujarat, India</b>		
Date of Registration	19/01/2023	
Title	KEY CHAIN HANGER	
Priority NA		

Design Number	378916-001	
Class	10-05	
<b>1. Prof. (Dr.) Sailesh Kumar Ghatuary Principal cum Director, Shri RLTI Institute of Pharmaceutical Science &amp; Technology. Eakdil, ETAWAH, Uttar Pradesh - 206126, India 2. Dr. Meenakshi Ratra VMS College of Pharmacy, Batala Said Mubarak, Amritsar Road Dist. Gurdaspur, Punjab - 143505, India 3. Kulwinder Singh VMS College of Pharmacy, Batala Said Mubarak, Amritsar Road Dist. Gurdaspur, Punjab - 143505, India 4. Mr. SHISHUPAL SEGOJI BODHANKAR Bajiraoji Karanjekar College of Pharmacy, Nagzira Road, Sakoli, Ta-Sakoli, Dist.- Bhandara, Maharashtra - 441802, India , et al.</b>		
Date of Registration	08/02/2023	
Title	FRIABILITY TESTER	
Priority NA		

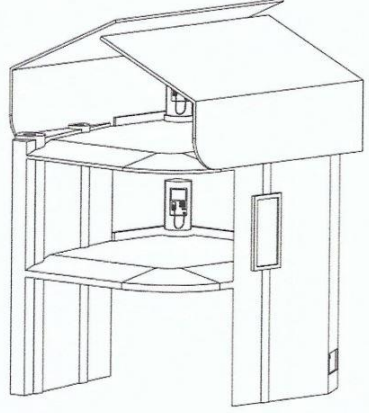
Design Number	366458-001	
Class	13-02	
<b>1. Radhey Shyam Meena eMaster Student, Department of Industrial and Mangament Engineering, Indian Institute of Technology, Kanpur, India 2. Dr. Parul Gupta Professor &amp; Director, B. N. College of Engineering &amp; Technology, NH -24, Sitapur Road, Near Sahara Art and Management, Bakshi Ka Talab, Lucknow-226201, Uttar Pradesh, India 3. Dr. Rupesh Kushwah Assistant Professor, Department of Chemistry, Government Shyam Sundar Agrawal PG College, Sihora, Jabalpur, Madhya Pradesh, India 4. Dr. Ram Bhawan Singh Director &amp; Professor, Department of Computer Science, Apex Institute of Technology, Rampur, Uttar Pradesh, India</b>		
Date of Registration	21/06/2022	
Title	Charging station for electric vehicle	
Priority NA		

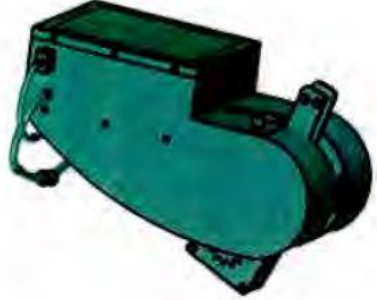
<b>Design Number</b>	313779-001	
<b>Class</b>	12-16	
<b>ANANT JAIN C/O Accelero Vehicles India Private Limited of 4634, Unit no.101, MGM Complex, Ansari Road, Darya Ganj, New Delhi-110002, INDIA.</b>		
<b>Date of Registration</b>	10/01/2019	
<b>Title</b>	RETROFIT KIT FOR BICYCLES	
<b>Priority NA</b>		

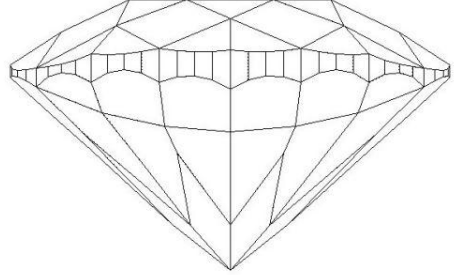
<b>Design Number</b>	379498-001	
<b>Class</b>	11-01	
<b>Lemon TechnnoMist (P) Ltd F02-06, Gujarat Hira Bourse, Gem &amp; Jewellery Park, Ichchhapore, Surat – 394510, Gujarat, India</b>		
<b>Date of Registration</b>	16/02/2023	
<b>Title</b>	GEMSTONE	
<b>Priority NA</b>		

<b>Design Number</b>	378693-001	
<b>Class</b>	23-04	
<b>MRS. SWATI BHUSHAN MARDE MR. BHUSHAN RAMCHANDRA MARDE A 2101 / 2201 , Matoshri Pearl, S Keer Road, Mahim (W), Mumbai - 4000 16, Maharashtra, India</b>		
<b>Date of Registration</b>	06/02/2023	
<b>Title</b>	Floor Grille	
<b>Priority NA</b>		

<b>Design Number</b>	347531-001	
<b>Class</b>	23-04	
<b>CET ENVIRO PRIVATE LIMITED Sr.No.171/A1, 171/B, 172/2, Br Vision, Akrurdi, Pune-411035, Maharashtra</b>		
<b>Date of Registration</b>	07/08/2021	
<b>Title</b>	Cooling towers	
<b>Priority NA</b>		



<b>Design Number</b>	378997-001	
<b>Class</b>	12-16	
<b>Suzuki Motor Corporation 300 Takatsuka-cho, Minami-ku, Hamamatsu-shi, Shizuoka 432-8611, Japan</b>		
<b>Date of Registration</b>	09/02/2023	
<b>Title</b>	Car Wheel	
<b>Priority</b>		
<b>Priority Number</b>	<b>Date</b>	<b>Country</b>
2022-017171	10/08/2022	Japan





<b>Design Number</b>	335473-001	
<b>Class</b>	25-01	
<b>Nav Nirman Formwork Systems Private Limited Plot No.6, Road No.7, IDA Nacharam, Hyderabad - 500076, Telangana, India</b>		
<b>Date of Registration</b>	23/11/2020	
<b>Title</b>	SLAB AND VERTICAL FORMWORK	
<b>Priority NA</b>		



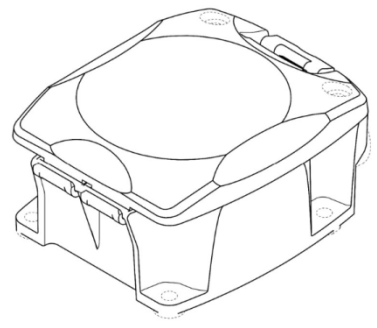

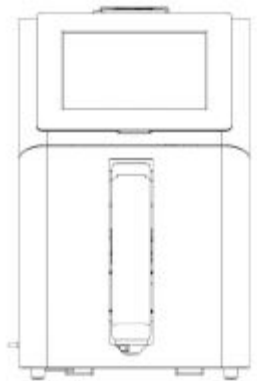
<b>Design Number</b>	379527-001		
<b>Class</b>	02-02		
<b>SABYASACHI CALCUTTA LLP 80/2 Topsia Road (South), Kolkata-700046, West Bengal.</b>			
<b>Date of Registration</b>	16/02/2023		
<b>Title</b>	GARMENT SET		
<b>Priority NA</b>			
<b>Design Number</b>	359821-001		
<b>Class</b>	07-01		
<b>1. CHITKARA UNIVERSITY (PUNJAB) CHITKARA UNIVERSITY, CHANDIGARH-PATIALA, NATIONAL HIGHWAY, VILLAGE JHANSLA, RAJPURA, PUNJAB - 140401, INDIA. 2. CHITKARA INNOVATION INCUBATOR FOUNDATION SCO: 160-161, SECTOR -9C, MADHYA MARG, CHANDIGARH-160009, INDIA. 3. MONIKA SETHI CSE CUIET, CHITKARA UNIVERSITY, CHANDIGARH-PATIALA NATIONAL HIGHWAY, VILLAGE JANSLA, RAJPURA, PUNJAB - 140401, INDIA. 4. SACHIN AHUJA CURIN CUIET, CHITKARA UNIVERSITY, CHANDIGARH-PATIALA NATIONAL HIGHWAY, VILLAGE JANSLA, RAJPURA, PUNJAB - 140401, INDIA. , et al.</b>			
<b>Date of Registration</b>	03/03/2022		
<b>Title</b>	GLASS WITH STRAW/SPOON HOLDER		
<b>Priority NA</b>			
<b>Design Number</b>	336051-001		
<b>Class</b>	10-04		
<b>DWYER INSTRUMENTS, INC. 102 Indiana Highway 212, Michigan City, Indiana 46360, USA.</b>			
<b>Date of Registration</b>	09/12/2020		
<b>Title</b>	DIFFERENTIAL PRESSURE TRANSMITTER		
<b>Priority</b>			
<b>Priority Number</b>	<b>Date</b>	<b>Country</b>	
29/737,687	11/06/2020	U.S.A.	

<b>Design Number</b>	378601-001	
<b>Class</b>	24-01	
<b>SENSA CORE MEDICAL INSTRUMENTATION PRIVATE LIMITED PLOT 3, EPIP, PASHAMYLARAM, HYDERABAD 502307, TELANGANA</b>		
<b>Date of Registration</b>	03/02/2023	
<b>Title</b>	SLANTED BLOOD GAS ANALYZER WITH CENTER PLACED SAMPLER	
<b>Priority NA</b>		
<b>Design Number</b>	379150-001	
<b>Class</b>	15-03	
<b>1.Dr.Barinderjit Singh Assistant Professor, Department of Food Science and Technology, I.K.Gujral Punjab Technical University, Kapurthala-144603, Punjab, India 2. Dr.Yashi Srivastava Assistant Professor, Department of Applied Agriculture, Central University of Punjab, Bathinda- 151401, Punjab, India 3. Ms.Reetu Assistant Professor, Department of Food Science and Technology, Maharaja Ranjit Singh Punjab Technical University, Bathinda, Punjab 151001, India 4. Dr.Sarvesh Rustagi Associate professor, Department of Food Technology, School of Applied and Life Sciences, Uttaranchal University, Dehradun, Uttarakhand-248007, India.</b>		
<b>Date of Registration</b>	12/02/2023	
<b>Title</b>	Portable Solar Onion Dryer	
<b>Priority NA</b>		
<b>Design Number</b>	357509-001	
<b>Class</b>	31-00	
<b>WayCool Foods and Products Pvt. Ltd. 6 &amp; 8 Bhagirathi Ammal Street, T Nagar, Chennai, Tamil Nadu 600017, India.</b>		
<b>Date of Registration</b>	28/01/2022	
<b>Title</b>	TAMARIND CUTTER	
<b>Priority NA</b>		

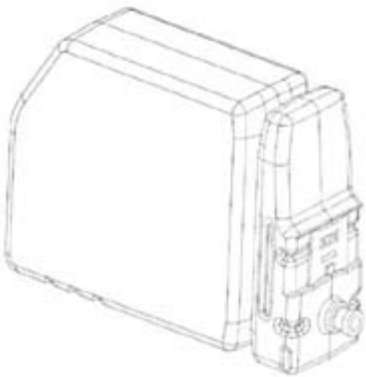
<b>Design Number</b>	345135-001		
<b>Class</b>	14-02		
<b>VIDEOJET TECHNOLOGIES INC. 1500 Mittel Boulevard, Wood Dale, IL 60191, United States of America.</b>			
<b>Date of Registration</b>	22/06/2021		
<b>Title</b>	INKJET CARTRIDGE		
<b>Priority</b>			
Priority Number	Date	Country	
29/763,606	23/12/2020	U.S.A.	

<b>Design Number</b>	340486-001		
<b>Class</b>	08-08		
<b>GRIPPLE LIMITED THE OLD WEST GUN WORKS, SAVILE STREET EAST, SHEFFIELD, S4 7UQ, UNITED KINGDOM.</b>			
<b>Date of Registration</b>	10/03/2021		
<b>Title</b>	JOINING ASSEMBLY		
<b>Priority</b>			
Priority Number	Date	Country	
008204762-0001	15/10/2020	EUIPO	

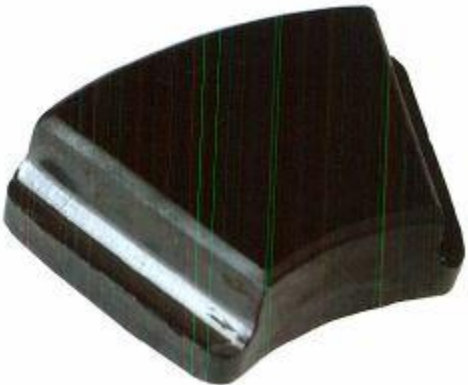
<b>Design Number</b>	377660-002		
<b>Class</b>	15-99		
<b>Shree Raj Industries 103, Rameshwar Estate, Opp. Krishna Park, B/h. Jay Chemical, Virat Nagar Road, Odhav, Ahmedabad-382415, Gujarat-India, Proprietor is Manishbhai Gordhanbhai Patel</b>			
<b>Date of Registration</b>	19/01/2023		
<b>Title</b>	THRUST BEARING PAD		
<b>Priority NA</b>			

<b>Design Number</b>	362181-001		
<b>Class</b>	12-16		
<b>TATA MOTORS LIMITED BOMBAY HOUSE, 24 HOMI MODY STREET, HUTATMA CHOWK, MUMBAI 400001, MAHARASHTRA, INDIA.</b>			
<b>Date of Registration</b>	08/04/2022		
<b>Title</b>	A PILLAR MOUNTED VISION BOX FOR DRIVER MONITORING SYSTEM		
<b>Priority NA</b>			
<b>Design Number</b>	346496-001		
<b>Class</b>	13-03		
<b>M/S. LOOKMAN ELECTROPLAST INDUSTRIES LTD NEW NO. 15, OLD NO. 9, 2ND STREET EXTN, 3RD MAIN ROAD, CIT NAGAR, NANDANAM, CHENNAI-600035, TAMIL NADU INDIA</b>			
<b>Date of Registration</b>	20/07/2021		
<b>Title</b>	PANIC SWITCH		
<b>Priority NA</b>			
<b>Design Number</b>	353764-001		
<b>Class</b>	14-01		
<b>SHENZHEN TECNO TECHNOLOGY CO., LTD 101, Building 24, Waijing Industrial Park, Fu Min Community, Fu Cheng Street, Longhua District, Shenzhen, China</b>			
<b>Date of Registration</b>	26/11/2021		
<b>Title</b>	Earphones with Case (Set)		
<b>Priority</b>			
<b>Priority Number</b>	<b>Date</b>	<b>Country</b>	
202130410850.X	30/06/2021	China	

<b>Design Number</b>	358351-001	
<b>Class</b>	02-02	
<b>Muskan beauty collections U-32/1, KARBALA ROAD, Near DM QUEEN ACTUAL, Matiyabruz, Kolkata 700018</b>		
<b>Date of Registration</b>	10/02/2022	
<b>Title</b>	FROCK	
<b>Priority NA</b>		
<b>Design Number</b>	333821-001	
<b>Class</b>	28-03	
<b>Ashok kumar G-10, New Madhavpura Market, Shaibug Road, Ahmedabad – 38000, Gujrat, , India</b>		
<b>Date of Registration</b>	01/10/2020	
<b>Title</b>	TRIMMER	
<b>Priority NA</b>		
<b>Design Number</b>	341931-001	
<b>Class</b>	07-02	
<b>WONDERCHEF HOME APPLIANCES PVT. LTD Unit No. 303, B Wing, Supreme Business Park, Supreme City, Hiranandani Gardens, Powai, Mumbai-400 076.</b>		
<b>Date of Registration</b>	05/04/2021	
<b>Title</b>	PAN FOR DOSA	
<b>Priority NA</b>		

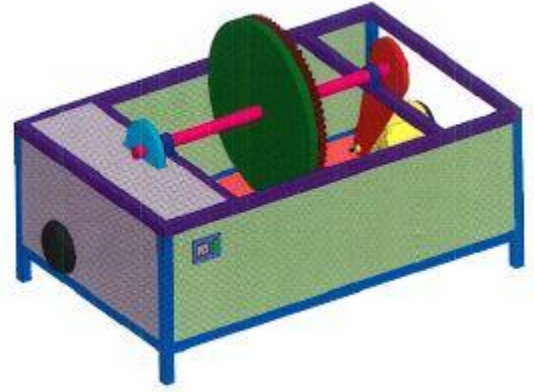

<b>Design Number</b>	378898-001	
<b>Class</b>	26-05	
<b>1. Shoolini University of Biotechnology and Management Sciences Bajhol, PO Sultanpur, Distt. Solan 173229 HP India 2. Harshita Sri School of Biotechnology, Shoolini University, Bajhol, Sultanpur, Solan HP</b>		
<b>Date of Registration</b>	08/02/2023	
<b>Title</b>	SINGING BOWL WITH LAMP	
<b>Priority NA</b>		
<b>Design Number</b>	333602-001	
<b>Class</b>	01-01	
<b>PARLE PRODUCTS PVT. LTD. North Level Crossing, Vile Parle (E), Mumbai-400057, Maharashtra</b>		
<b>Date of Registration</b>	25/09/2020	
<b>Title</b>	BISCUIT	
<b>Priority NA</b>		
<b>Design Number</b>	332274-001	
<b>Class</b>	26-03	
<b>SHYAM SUNDER JINDAL A-167, 2ND FLOOR, PHASE-1, ASHOK NAGAR, DELHI-110052</b>		
<b>Date of Registration</b>	24/08/2020	
<b>Title</b>	LED LIGHT	
<b>Priority NA</b>		

<b>Design Number</b>	376548-001	
<b>Class</b>	13-01	
<b>Title</b>	1.Sri Manakula Vinayagar Engineering College Madagadipet, Puducherry - 605 107, India. 2. Dr. V. S. K. Venkatachalapathy Director cum Principal, Sri Manakula Vinayagar Engineering College, Madagadipet, Puducherry - 605 107, India. 3. Dr. K. Velmurugan Head and Dean Research, Department of Mechanical Engineering, Sri Manakula Vinayagar Engineering College, Madagadipet, Puducherry - 605 107, India. 4. A. Dhanush Kumar Department of Mechanical Engineering, Sri Manakula Vinayagar Engineering College, Madagadipet, Puducherry - 605 107, India. , et al.	
<b>Date of Registration</b>	02/01/2023	
<b>Title</b>	FLYWHEEL POWER GENERATING SYSTEM	
<b>Priority NA</b>		
<b>Design Number</b>	379060-001	
<b>Class</b>	09-03	
<b>Title</b>	ORION CORPORATION 13, Baekbeom-ro 90da-gil, Yongsan-gu, Seoul 04369 Republic of Korea	
<b>Date of Registration</b>	10/02/2023	
<b>Title</b>	BOX FOR FOOD PACKAGING	
<b>Priority NA</b>		
<b>Design Number</b>	373635-001	
<b>Class</b>	24-02	
<b>Title</b>	Sensile Medical AG Solothurnerstraße 235, 4600 Olten, Schweiz	
<b>Date of Registration</b>	05/11/2022	
<b>Title</b>	INJECTORS FOR MEDICAL USE	
<b>Priority</b>		
<b>Priority Number</b>	<b>Date</b>	<b>Country</b>
009018435	06/05/2022	EUIPO



Design Number	379225-001	
Class	30-12	
Shivam Polymers B-16 Site B, Surajpur Industrial Area, Greater Noida-201306, UP, India		
Date of Registration	13/02/2023	
Title	Toy for pets	
Priority NA		
Design Number	343982-001	
Class	07-02	
Kaldis Brew Private Limited Shop No.1, Prince Vaibhav, Village Road, Bhandup (w), Mumbai - 400078		
Date of Registration	28/05/2021	
Title	COFFEE MAKER	
Priority NA		
Design Number	358015-001	
Class	07-02	
1. CHITKARA INNOVATION INCUBATOR FOUNDATION SCO: 160-161, SECTOR -9C, MADHYA MARG, CHANDIGARH- 160009, INDIA. 2. SUSHEELA HOODA CSE, CUIET, CHITKARA UNIVERSITY, PUNJAB. 3. ANSHU SINGLA CHITKARA UNIVERSITY INSTITUTE OF ENGINEERING AND TECHNOLOGY, PUNJAB, INDIA. 4. AMANDEEP KAUR CHITKARA UNIVERSITY INSTITUTE OF ENGINEERING AND TECHNOLOGY, PUNJAB, INDIA. , et al.		
Date of Registration	07/02/2022	
Title	AUTOMATIC SECURED GAS-STOVE	
Priority NA		

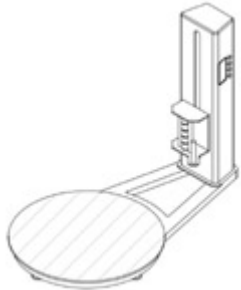

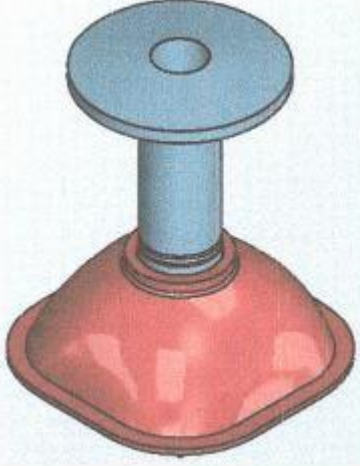
<b>Design Number</b>	354210-001	
<b>Class</b>	15-09	
<b>1. Dr. Swarnambuj Suman Assistant Professor, Department of Mechanical Engineering, National Institute of Technology Patna, Patna University Campus, Patna, Bihar – 800005. 2. Mr. V. Ravi Raj Associate Professor, Department of Mechanical Engineering, Sri Sairam Engineering College, West Tambaram, Chennai – 600044. 3. Dr. Chandrika V S Associate Professor, Department of Electrical and Electronics Engineering, KPR Institute of Engineering and Technology, Coimbatore – 641407. 4. Dr. Radhika Baskar Professor, Institute of ECE, Saveetha School of Engineering, Saveetha Institute of Medical and Technical Sciences, Chennai-602105. , et al.</b>		
<b>Date of Registration</b>	03/12/2021	
<b>Title</b>	AN INDUSTRIAL DEVICE FOR PALLET WRAPPING	
<b>Priority NA</b>		
<b>Design Number</b>	378804-001	
<b>Class</b>	11-01	
<b>SABYASACHI CALCUTTA LLP 80/2 Topsia Road (South), Kolkata-700046, West Bengal.</b>		
<b>Date of Registration</b>	06/02/2023	
<b>Title</b>	JEWELLERY	
<b>Priority NA</b>		
<b>Design Number</b>	377858-001	
<b>Class</b>	07-04	
<b>Lyca Food Private Limited Plot No - 556, Kiit Road, Phase-II, Kanan Vihar, Chandrasekharapur, Bhubaneswar, Odisha 751024, India</b>		
<b>Date of Registration</b>	23/01/2023	
<b>Title</b>	COCO BIT	
<b>Priority NA</b>		

<b>Design Number</b>	379020-001	
<b>Class</b>	03-01	
<b>SAMSUNG ELECTRONICS CO., LTD. 129, Samsung-ro, Yeongtong-gu, Suwon-si, Gyeonggi-do, Republic of Korea</b>		
<b>Date of Registration</b>	09/02/2023	
<b>Title</b>	CASE FOR MOBILE PHONE	
<b>Priority</b>		
<b>Priority Number</b>	<b>Date</b>	<b>Country</b>
30-2022-0032788	12/08/2022	Republic of Korea

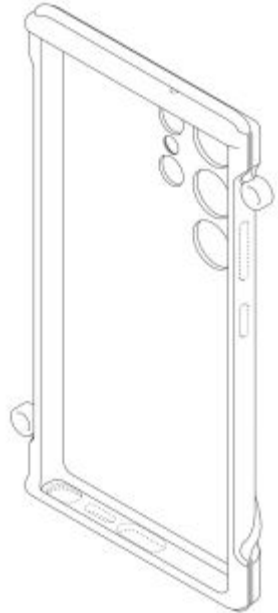

<b>Design Number</b>	368707-001	
<b>Class</b>	07-09	
<b>Aby Paul Padinjarekudiyil, Pattal Quarry Road, Near BSNL Quarters, Perumbavoor, iringole, Ernakulam, Kerala- 683548</b>		
<b>Date of Registration</b>	03/08/2022	
<b>Title</b>	Rice Drain Stand	
<b>Priority NA</b>		

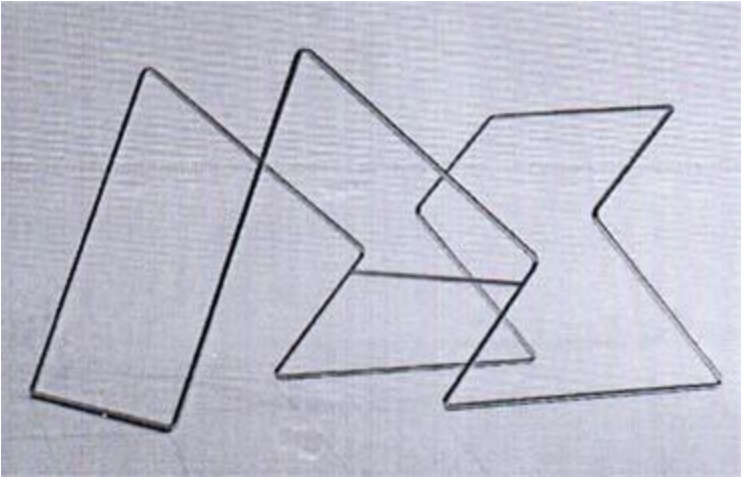



<b>Design Number</b>	378644-001	
<b>Class</b>	26-05	
<b>Light and Shade Electricals Private Limited 11 to 20 and 108 to 114, Luthria House, Sativali Road, Vasai East, District : Palghar, 401208</b>		
<b>Date of Registration</b>	03/02/2023	
<b>Title</b>	STEP MARKER LIGHT	
<b>Priority NA</b>		

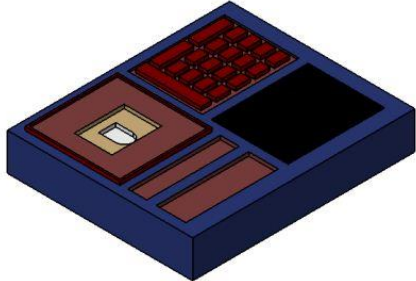

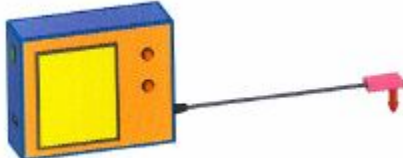
<b>Design Number</b>	362522-001	
<b>Class</b>	14-02	
<b>1. CHITKARA UNIVERSITY (PUNJAB) CHITKARA UNIVERSITY, CHANDIGARH-PATIALA, NATIONAL HIGHWAY, VILLAGE JHANSLA, RAJPURA, PUNJAB - 140401, INDIA. 2. CHITKARA INNOVATION INCUBATOR FOUNDATION SCO: 160-161, SECTOR -9C, MADHYA MARG, CHANDIGARH- 160009, INDIA. 3. SURITI GOEL CGE, CBS, CHITKARA UNIVERSITY, PUNJAB, 140401, INDIA. 4. AMANDEEP KAUR CSE, CUIET, CHITKARA UNIVERSITY, PUNJAB, 140401, INDIA. , et al.</b>		
<b>Date of Registration</b>	13/04/2022	
<b>Title</b>	SAFE AND SMART BIOMETRIC MACHINE WITH FAR-UVC	
<b>Priority NA</b>		

<b>Design Number</b>	376542-002	
<b>Class</b>	10-05	
<b>1. Sri Manakula Vinayagar Engineering College Madagadipet, Puducherry - 605 107, India 2. Dr. R. Raju Professor &amp; Head, Department of Information Technology, Sri Manakula Vinayagar Engineering College, Madagadipet, Puducherry - 605 107, India 3. Dr. S. Balaji Associate Professor, Department of Information Technology, Sri Manakula Vinayagar Engineering College, Madagadipet, Puducherry - 605 107, India 4. Dr. R. Saravanan Associate Professor, Department of Information Technology, Sri Manakula Vinayagar Engineering College, Madagadipet, Puducherry - 605 107, India , et al.</b>		
<b>Date of Registration</b>	02/01/2023	
<b>Title</b>	IOT BASED WATER LEAKAGE DETECTION AND MONITORING SYSTEM	
<b>Priority NA</b>		

<b>Design Number</b>	364343-001	
<b>Class</b>	21-02	
<b>BRIGHT STAR INC A/6, UNITY INDUSTRIAL PARK, B/H. AVI STEEL PROCESSORS, BAKROL-DHAMATVAN ROAD, DHAMATVAN, AHMEDABAD-382435, GUJARAT, INDIA.</b>		
<b>Date of Registration</b>	18/05/2022	
<b>Title</b>	Rattle Toy	
<b>Priority NA</b>		

<b>Design Number</b>	365946-001	
<b>Class</b>	13-03	
<b>V. K. INDUSTRIES 16, MEHTA INDUSTRIAL ESTATE, 3RD LIBERTY GARDEN X LANE, MALAD WEST, MUMBAI-400064, INDIA</b>		
<b>Date of Registration</b>	12/06/2022	
<b>Title</b>	MODULAR SWITCH PLATE	
<b>Priority NA</b>		

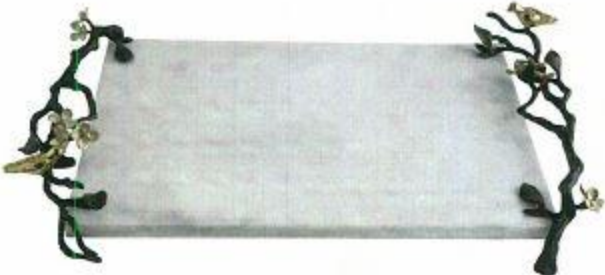
<b>Design Number</b>	376608-008	
<b>Class</b>	07-01	
<b>MICHAEL ARAM INDIA PRIVATE LIMITED A-41,SECTOR - 80,PHASE-II,NOIDA-201305,U.P.INDIA</b>		
<b>Date of Registration</b>	03/01/2023	
<b>Title</b>	CHEESE BOARD.	
<b>Priority NA</b>		

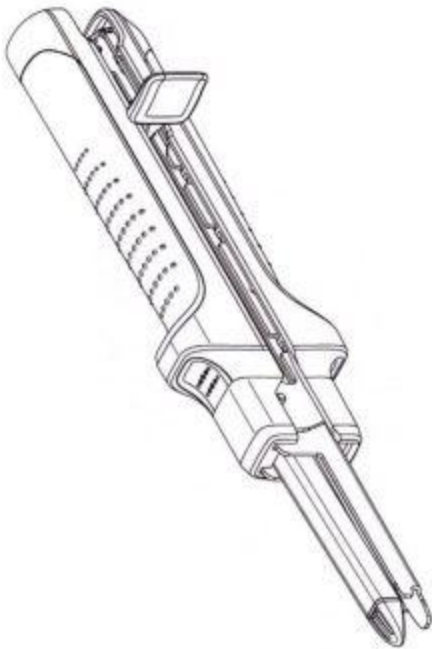
<b>Design Number</b>	375513-001		
<b>Class</b>	24-02		
<b>Cilag GmbH International Gubelstrasse 34, CH 6300, Zug, Switzerland</b>			
<b>Date of Registration</b>	12/12/2022		
<b>Title</b>	LINEAR SURGICAL STAPLER		
<b>Priority</b>			
<b>Priority Number</b>	<b>Date</b>	<b>Country</b>	
29/842,581	14/06/2022	U.S.A.	

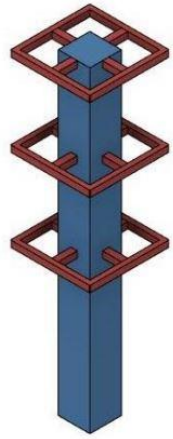
Design Number	379309-001	
Class	15-03	
Genminds Skill Trainings and Technological Services Private Limited 29-922/1, Besides Khasim Garu House, Vinukonda, Guntur, Andhra Pradesh, India,522647		
Date of Registration	15/02/2023	
Title	FRUIT HARVESTER	
Priority NA		

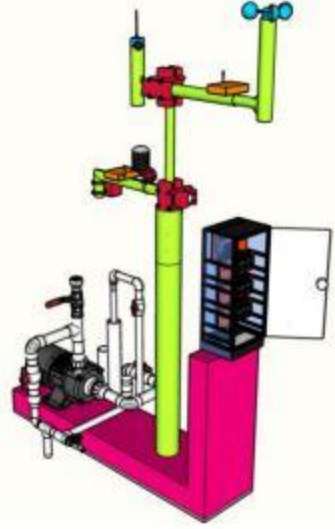

Design Number	379499-001	
Class	15-03	
1. Dr. S. Kavitha Assistant Professor Computer Science and Applications Auxilium College(Autonomous) Vellore-632006, Tamil Nadu 2. Dr. R. Shobana Assistant Professor Computer Science and Applications Auxilium College(Autonomous) Vellore-632006 Tamil Nadu 3. Dr. C.S.NITHYA Guest Lecturer COMPUTER SCIENCE Kalaignar Karunanidhi Government Arts College Tiruvannamalai-606603 Tamil Nadu 4. Dr. N.Sathya Assistant Professor, Grade 1 Commerce Vellore Institute of Technology Vellore-632 014 , et al.		
Date of Registration	16/02/2023	
Title	IOT BASED SMART IRRIGATION SYSTEM	
Priority NA		

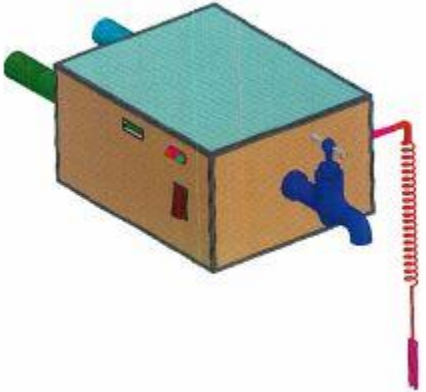

Design Number	349787-001	
Class	25-01	
Siri Maharaja Granites Private Limited E-315A, Road No. 16, VKIA, Sikar Road - Jaipur - 302013, Rajasthan, India		
Date of Registration	20/09/2021	
Title	Tiles	
Priority NA		

Design Number	379776-001	
Class	24-01	
1. Dr. Sachinkumar Dnyaneshwar Gunjal Amrutvahini College of Pharmacy, Sangamner, Tal- Sangamner, Dist-Ahmednagar, Maharashtra, India, S 2. Ashish Jaiswal Ph.D (Microbiology), Division of Microbiology, School of Pharmaceutical & Health Sciences, Career Point University, Hamirpur, Himachal Pradesh, 176041, India 3. Kajal Mahawar Assistant Professor in Computer Application & Science Department, St. Aloysius' College (Autonomous), Jabalpur (M. P.), India 4. Ms. Linda Xavier Research Scholar, Department of Child Health Nursing, Saveetha College of Nursing, Saveetha Institute of Medical and Technical Science, Thandalam- 602105 , et al.		
Date of Registration	21/02/2023	
Title	BIOSENSORS EQUIPPED LUNG CANCER DETECTING DEVICE	
Priority NA		

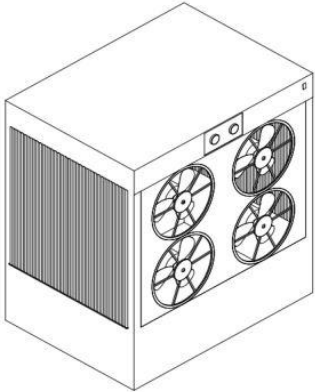
Design Number	376447-001	
Class	23-01	
1. R RAJBHARATH ASSISTANT PROFESSOR, DEPARTMENT OF COMPUTER SCIENCE AND ENGINEERING, MANAKULA VINAYAGAR INSTITUTE OF TECHNOLOGY, KALITHEERTHALKUPPAM, PUDUCHERRY-605107, INDIA 2. DR N PALANIVEL ASSOCIATE PROFESSOR, DEPARTMENT OF COMPUTER SCIENCE AND ENGINEERING, MANAKULA VINAYAGAR INSTITUTE OF TECHNOLOGY, KALITHEERTHALKUPPAM, PUDUCHERRY-605107, INDIA		
Date of Registration	30/12/2022	
Title	WATER DETECTING SENSOR WITH AUTOMATIC DUAL INLET WATER TAP	
Priority NA		

Design Number	371901-001	
Class	23-04	
1. GD MIDEA HEATING & VENTILATING EQUIPMENT CO., LTD. Penglai Industry Road, Beijiao, Shunde, Foshan, Guangdong, 528311, China 2. HEFEI MIDEA HEATING & VENTILATING EQUIPMENT CO., LTD. No. 88, Chuangxin Avenue, Boyan Science Park, High-Tech Zone, Hefei, Anhui 230601, China		
Date of Registration	01/10/2022	
Title	INDOOR UNIT FOR AIR CONDITIONER	
Priority		
Priority Number	Date	Country
202230181588.0	01/04/2022	China

<b>Design Number</b>	377040-001		
<b>Class</b>	23-03		
<b>Kamalkishor N. Laddha "PADMAREKHA" 26, Vasant Nagar, Jawahar Colony, Trimurti Chowk, Near Saibaba Mandir, Aurangabad - 431005 (Maharashtra)</b>			
<b>Date of Registration</b>	09/01/2023		
<b>Title</b>	WATER HEATER		
<b>Priority NA</b>			
<b>Design Number</b>	379306-001		
<b>Class</b>	23-04		
<b>1. Pawan Kumar House no.283a, Masjid Wali Gali, Bakhtawarpur, New Delhi, 110036. 2. Rohit Verma House no.283a, Masjid Wali Gali, Bakhtawarpur, New Delhi, 110036. 3. Dr. Shakti Arora Panipat Institute of Engineering &amp; Technology, Pattikalayana, Samalakra, Panipat, Haryana.</b>			
<b>Date of Registration</b>	14/02/2023		
<b>Title</b>	Cooler Assembly		
<b>Priority NA</b>			
<b>Design Number</b>	342604-001		
<b>Class</b>	29-02		
<b>LG ELECTRONICS INC. 128, YEOUNG-DAERO, YEONGDEUNGPO -GU, SEOUL, 07336, REPUBLIC OF KOREA</b>			
<b>Date of Registration</b>	21/04/2021		
<b>Title</b>	FILTER PAD FOR MASK TYPE AIR PURIFIER		
<b>Priority</b>			
<b>Priority Number</b>	<b>Date</b>	<b>Country</b>	
30-2020-0053141	04/11/2020	Republic of Korea	

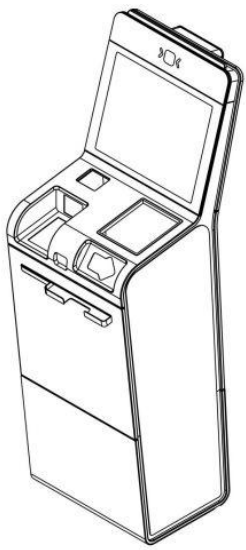
<b>Design Number</b>	336879-001		
<b>Class</b>	08-06		
<b>JAY SHREE KRUSHNA TRADING CO. 408, GIDC MANJUSAR (SAVLI), NEAR BOMBARDIAR CIRCLE, DIST. VADODARA - 391775, GUJARAT - INDIA</b>			
<b>Date of Registration</b>	28/12/2020		
<b>Title</b>	MAGNETIC DOOR STOP		
<b>Priority NA</b>			
<b>Design Number</b>	379405-001		
<b>Class</b>	02-02		
<b>SABYASACHI CALCUTTA LLP 80/2 Topsia Road (South), Kolkata-700046, West Bengal.</b>			
<b>Date of Registration</b>	15/02/2023		
<b>Title</b>	LADIES GARMENT (SET)		
<b>Priority NA</b>			
<b>Design Number</b>	375486-001		
<b>Class</b>	14-02		
<b>SITA B.V. Blaak 555 NL-3011 GB Rotterdam The Netherlands</b>			
<b>Date of Registration</b>	12/12/2022		
<b>Title</b>	DATA PROCESSING EQUIPMENT		
<b>Priority</b>			
<b>Priority Number</b>	<b>Date</b>	<b>Country</b>	
009060056-0002	13/06/2022	EUIPO	

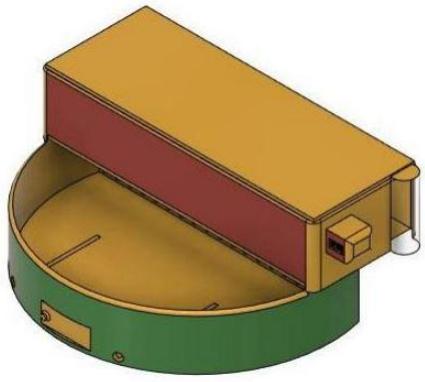

<b>Design Number</b>	378911-001	
<b>Class</b>	24-01	
<b>1. Abhishek Chander C-464, Yojna Vihar, New Delhi 110092 2. Dr. Ayushi Chander C-464, Yojna Vihar, New Delhi</b>		
<b>Date of Registration</b>	08/02/2023	
<b>Title</b>	Catheter mount with auto adjustable inputs including MDI	
<b>Priority NA</b>		

<b>Design Number</b>	379632-001	
<b>Class</b>	30-03	
<b>Genminds Skill Trainings and Technological Services Private Limited 29-922/1, Besides Khasim Garu House, Vinukonda, Guntur, Andhra Pradesh, India, 522647, India</b>		
<b>Date of Registration</b>	20/02/2023	
<b>Title</b>	AUTOMATIC CATTLE FEEDER	
<b>Priority NA</b>		

<b>Design Number</b>	319928-001	
<b>Class</b>	07-02	
<b>LIZA INDUSTRIES 16/62, YASHWANT NAGAR, ROAD No. 1, NEAR APNA BAZAAR, GOREGAON (W), MUMBAI- 400062</b>		
<b>Date of Registration</b>	24/07/2019	
<b>Title</b>	CASSEROLE	
<b>Priority NA</b>		

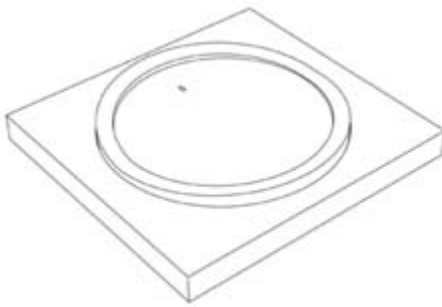
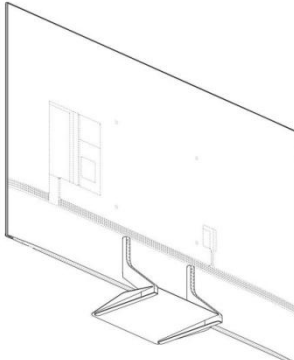
<b>Design Number</b>	343820-001		
<b>Class</b>	14-06		
<b>Samsung Electronics Co., Ltd. 129, Samsung-ro, Yeongtong-gu, Suwon-si, Gyeonggi-do, 16677, Republic of Korea</b>			
<b>Date of Registration</b>	25/05/2021		
<b>Title</b>	STAND FOR TELEVISION RECEIVER		
<b>Priority</b>			
Priority Number	Date	Country	
30-2020-0058800	01/12/2020	Republic of Korea	
<b>Design Number</b>	344142-001		
<b>Class</b>	14-03		
<b>SOMFY ACTIVITES SA 50 Avenue du Nouveau Monde 74300 CLUSES FRANCE</b>			
<b>Date of Registration</b>	02/06/2021		
<b>Title</b>	Remote control		
<b>Priority</b>			
Priority Number	Date	Country	
008309827-0001	04/12/2020	EUIPO	
<b>Design Number</b>	379468-001		
<b>Class</b>	14-03		
<b>Samsung Electronics Co., Ltd. 129, Samsung-ro, Yeongtong-gu, Suwon-si, Gyeonggi-do 16677, Republic of Korea</b>			
<b>Date of Registration</b>	16/02/2023		
<b>Title</b>	TELEVISION		
<b>Priority</b>			
Priority Number	Date	Country	
30-2022-0034526	24/08/2022	Republic of Korea	

<b>Design Number</b>	322628-001	
<b>Class</b>	12-16	
<b>Hero MotoCorp Limited 34, Community Center, Basant Lok, Vasant Vihar, New Delhi - 110057</b>		
<b>Date of Registration</b>	18/10/2019	
<b>Title</b>	SWITCH FOR TWO WHEELED VEHICLE	
<b>Priority NA</b>		
<b>Design Number</b>	376222-001	
<b>Class</b>	12-16	
<b>1.SIMATS SCHOOL OF ENGINEERING SIMATS SCHOOL OF ENGINEERING, SAVEETHA NAGAR, THANDALAM, CHENNAI-602105, TAMILNADU, INDIA 2. HARSHAVARDHAN G HARSHAVARDHAN G, DEPARTMENT OF COMPUTER SCIENCE AND ENGINEERING, SIMATS SCHOOL OF ENGINEERING, SAVEETHA NAGAR, THANDALAM, CHENNAI-602105, TAMILNADU, INDIA 3. MR V ASHWIN MR V ASHWIN, DEPARTMENT OF PLACEMENT AND TRAINING, SIMATS SCHOOL OF ENGINEERING, SAVEETHA NAGAR, THANDALAM, CHENNAI-602105, TAMILNADU, INDIA 4. DR RAMYA MOHAN DR RAMYA MOHAN, DEPARTMENT OF COMPUTER SCIENCE AND ENGINEERING, SIMATS SCHOOL OF ENGINEERING, SAVEETHA NAGAR, THANDALAM, CHENNAI-602105, TAMILNADU, INDIA , et al.</b>		
<b>Date of Registration</b>	27/12/2022	
<b>Title</b>	CHASSIS FOR SOLAR POWERED ROAD VEHICLE	
<b>Priority NA</b>		
<b>Design Number</b>	378402-001	
<b>Class</b>	02-02	
<b>PRAKASH KHATRI PROPRIETOR OF KHUSHAL NEAR SANGANER STADIUM, G11, LAXMI PALACE, SANGANER, JAIPUR, RAJASTHAN-302029</b>		
<b>Date of Registration</b>	01/02/2023	
<b>Title</b>	GARMENTS	
<b>Priority NA</b>		

<b>Design Number</b>	333818-001	
<b>Class</b>	28-03	
<b>Ashok kumar t G-10, New Madhavpura Market, Shaibug Road, Ahmedabad – 38000, Gujrat, India</b>		
<b>Date of Registration</b>	01/10/2020	
<b>Title</b>	Trimmer	
<b>Priority NA</b>		

<b>Design Number</b>	378903-001	
<b>Class</b>	23-04	
<b>RAJ COOLING SYSTEMS PRIVATE LIMITED, SURVEY NO. 31, PLOT NO. 58, HOTEL KRISHNA PARK, NEAR FALCON PUMPS PVT LTD, GONDAL ROAD, VAVDI, RAJKOT 360004, GUJARAT, INDIA.</b>		
<b>Date of Registration</b>	08/02/2023	
<b>Title</b>	AIR COOLER	
<b>Priority NA</b>		

<b>Design Number</b>	370919-001		
<b>Class</b>	28-03		
<b>KONINKLIJKE PHILIPS N.V. Eindhoven, whose post-office address is High Tech Campus 52, 5656 AG Eindhoven, The Netherlands.</b>			
<b>Date of Registration</b>	16/09/2022		
<b>Title</b>	CLIPPER		
<b>Priority</b>			
<b>Priority Number</b>	<b>Date</b>	<b>Country</b>	
008890123	17/03/2022	EUIPO	

<b>Design Number</b>	355392-001	
<b>Class</b>	03-01	
<b>SHARDA UNIVERSITY Plot No. 32, 34, Knowledge Park III, Greater Noida, Uttar Pradesh 201310</b>		
<b>Date of Registration</b>	22/12/2021	
<b>Title</b>	HAND SANITIZER WITH KEYRING	
<b>Priority NA</b>		

<b>Design Number</b>	361306-001
<b>Class</b>	15-09
<b>BLAL STEEL SHREDDING PVT. LTD. VILL. BISHANPURA, DORAHHA-PAYAL ROAD, NEAR PREM BRICK WORKS, LUDHIANA - 141416 (PB) INDIA</b>	
<b>Date of Registration</b>	26/03/2022
<b>Title</b>	SHREDDER FLUFF OUTLET HOUSING
<b>Priority NA</b>	

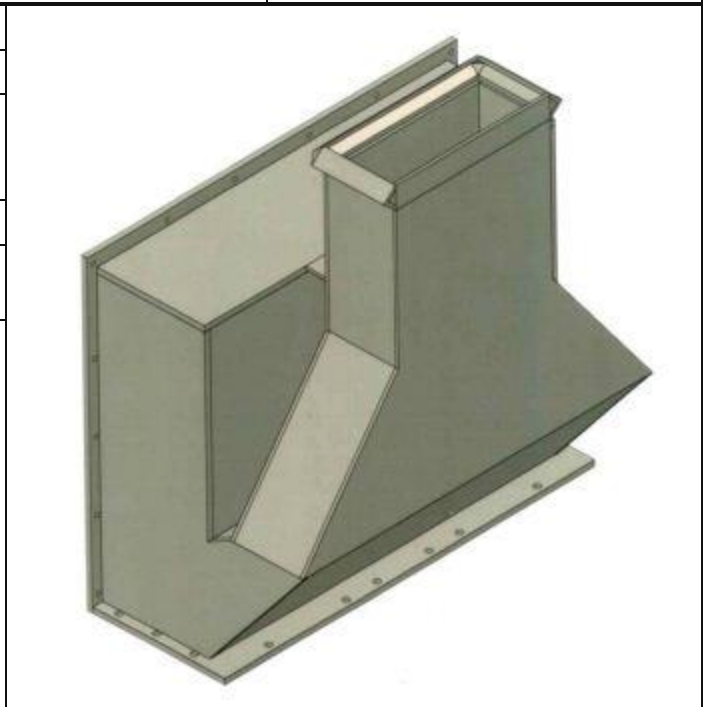

<b>Design Number</b>	378998-001	
<b>Class</b>	12-08	
<b>Suzuki Motor Corporation 300 Takatsuka-cho, Minami-ku, Hamamatsu-shi, Shizuoka 432-8611, Japan</b>		
<b>Date of Registration</b>	09/02/2023	
<b>Title</b>	Car	
<b>Priority</b>		
Priority Number	Date	Country
2022-017172	10/08/2022	Japan

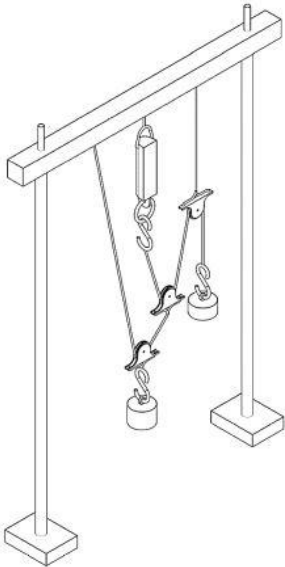
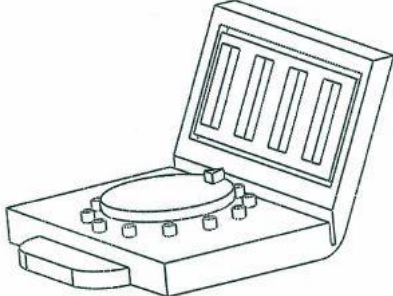

<b>Design Number</b>	379092-001	
<b>Class</b>	10-02	
<b>1.NES International School Mumbai Agrawal Rd, Opposite Sardar Pratap Singh Garden, Swapna Nagari, Mulund West, Mumbai-400082, Maharashtra , India 2. Shaurya Balasubramanian 2203,22nd floor,Cypress(Tower 5),Runwal Greens,besides Fortis Hospital,Mulund-Goregaon Link Road,Bhandup(West) Mumbai-400078,Maharashtra,India</b>		
<b>Date of Registration</b>	10/02/2023	
<b>Title</b>	SMART WATCH	
<b>Priority NA</b>		
<b>Design Number</b>	378725-001	
<b>Class</b>	11-01	
<b>SABYASACHI CALCUTTA LLP 80/2 Topsia Road (South), Kolkata-700046, West Bengal.</b>		
<b>Date of Registration</b>	06/02/2023	
<b>Title</b>	JEWELLERY (SET)	
<b>Priority NA</b>		
<b>Design Number</b>	379425-001	
<b>Class</b>	21-02	
<b>VENKATAGIREPPA DASARI NARASIMHAIAH No. 16, Ground Floor, 11th Cross, Thimaiah Garden, RT Nagar, Bengaluru.,</b>		
<b>Date of Registration</b>	16/02/2023	
<b>Title</b>	EXERCISE APPARATUS	
<b>Priority NA</b>		

<b>Design Number</b>	379301-001	
<b>Class</b>	02-03	
<b>1.MIT SQUARE SERVICES PRIVATE LIMITED No. 20, Neeraja Haleyon Villas, Banjara Layout Main Road, Horamavu Agara, Bengaluru-560043, Karnataka, India 2. M. THAMIZHARASI Department of Computer Science Engineering, SRM Institute of Science and Technology, Ramapuram Bharathi Salai, Ramapuram, Chennai, Tamil Nadu 600089, India 3. K. SIVASANKARI Department of Computer Science Engineering, SRM Institute of Science and Technology, Ramapuram Bharathi Salai, Ramapuram, Chennai, Tamil Nadu 600089, India 4. C. ASHWINI Department of Computer Science Engineering, SRM Institute of Science and Technology, Ramapuram Bharathi Salai, Ramapuram, Chennai, Tamil Nadu 600089, India , et al.</b>		
<b>Date of Registration</b>	14/02/2023	
<b>Title</b>	MULTIPURPOSE SMART HELMET	
<b>Priority NA</b>		
<b>Design Number</b>	379308-001	
<b>Class</b>	19-07	
<b>1.Shah and Anchor Kutchhi Engineering College Mahavir Education Trust Chowk, W. T. Patil Marg, Near Dukes Company, Chembur, Mumbai- 400 088 2. Naman Dhaval Desai Shah &amp; Anchor Kutchhi Engineering College, Mahavir Education Trust Chowk, W. T. Patil Marg, Near Dukes Company, Chembur, Mumbai- 400 088 3. Swapnil Janardan More Shah &amp; Anchor Kutchhi Engineering College, Mahavir Education Trust Chowk, W. T. Patil Marg, Near Dukes Company, Chembur, Mumbai- 400 088</b>		
<b>Date of Registration</b>	15/02/2023	
<b>Title</b>	EXPERIMENTAL SETUP	
<b>Priority NA</b>		
<b>Design Number</b>	377726-001	
<b>Class</b>	14-02	
<b>1.Dr. M. Vidhya Lakshmi Assistant Professor, Department of ECE, SRM Institute of Science and Technology, Ramapuram-600089, Tamil Nadu, India 2. Dr. R.Lathamanju Associate Professor, Department of ECE, SRM Institute of Science and Technology, Ramapuram-600089, Tamil Nadu, India 3. Mr.C.Aravindan Assistant Professor, Department of ECE, SRM Institute of Science and Technology, Ramapuram-600089, Tamil Nadu, India 4. Mr. N. Mahesh Kumar Assistant Professor, Department of ECE, SRM Institute of Science and Technology, Ramapuram-600089, Tamil Nadu, India</b>		
<b>Date of Registration</b>	20/01/2023	
<b>Title</b>	ARTIFICIAL INTELLIGENCE HOROSCOPE DEVICE	
<b>Priority NA</b>		

<b>Design Number</b>	361968-001	
<b>Class</b>	12-16	
<b>Ford Global Technologies, LLC 330 Town Center Drive, Suite 800, Dearborn Michigan, 48126, United States of America</b>		
<b>Date of Registration</b>	05/04/2022	
<b>Title</b>	Front Lower Bumper Cover	
<b>Priority</b>		
Priority Number	Date	Country
402021100966.3	20/10/2021	Germany

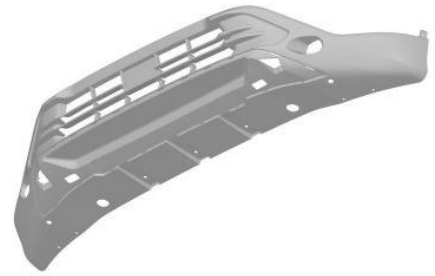



<b>Design Number</b>	378481-001	
<b>Class</b>	19-06	
<b>Luxor Writing Instruments Private Limited Plot No.229, Okhla Industrial Estate, Phase-III, South Delhi, Delhi - 110 020, India</b>		
<b>Date of Registration</b>	02/02/2023	
<b>Title</b>	WRITING INSTRUMENT	
<b>Priority NA</b>		

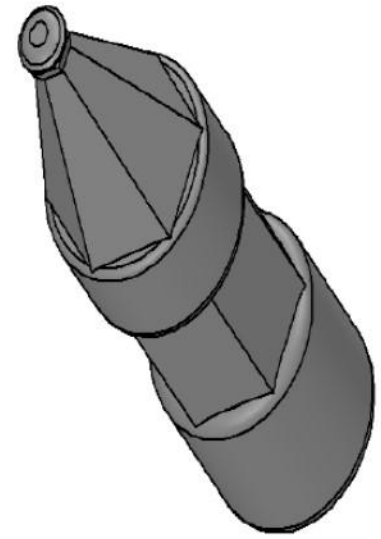

<b>Design Number</b>	335765-001	
<b>Class</b>	09-01	
<b>1. K.J.Karuppuswamy Assistant professor, Department of MBA, SNS College of Engineering, Coimbatore - 641107 2. R. Ramya Assistant professor, Department of MBA, SNS College of Engineering, Coimbatore - 641107 3. R.Anitha HOD &amp; Associate professor, Department of MBA, SNS College of Engineering, Coimbatore - 641107 4. G.Maheswaran Associate professor, Department of MBA, SNS College of Engineering, Coimbatore - 641107</b>		
<b>Date of Registration</b>	02/12/2020	
<b>Title</b>	BOTTLE	
<b>Priority NA</b>		





<b>Design Number</b>	379217-001	
<b>Class</b>	11-01	
<b>APALA 6, Hauz Khas Village, New Delhi-110016, India</b>		
<b>Date of Registration</b>	13/02/2023	
<b>Title</b>	RING	
<b>Priority NA</b>		
<b>Design Number</b>	347351-001	
<b>Class</b>	28-03	
<b>CAI ZHENGHAO LAOZHAI DAGUTANG VILLAGE, CIXI CITY, ZHEJIANG PROVINCE, CHINA</b>		
<b>Date of Registration</b>	05/08/2021	
<b>Title</b>	HAIR TRIMMER	
<b>Priority NA</b>		
<b>Design Number</b>	359828-001	
<b>Class</b>	02-02	
<b>Harpreet Narula Kabbalah, C-66, Sector-4, Noida- 201301, Uttar Pradesh, INDIA</b>		
<b>Date of Registration</b>	03/03/2022	
<b>Title</b>	Garment Set	
<b>Priority NA</b>		

<b>Design Number</b>	361108-001	
<b>Class</b>	14-02	
<b>VEEA INC. 164 East 83rd Street, New York, New York 10028, United States of America.</b>		
<b>Date of Registration</b>	23/03/2022	
<b>Title</b>	COMPUTING DEVICE HOUSING	
<b>Priority</b>		
Priority Number	Date	Country
29/809,755	29/09/2021	U.S.A.

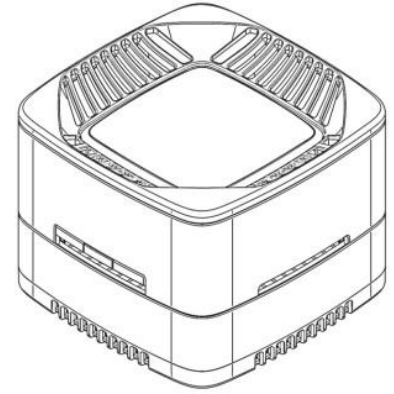



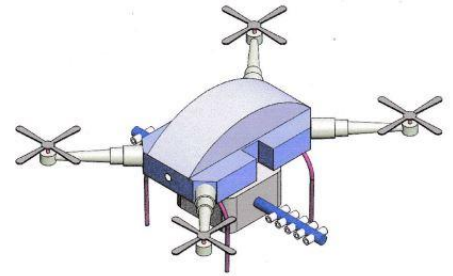

<b>Design Number</b>	369579-001	
<b>Class</b>	12-07	
<p>1. Dr. K. SRIDHAR Professor, Department of Mechanical Engineering, Lendi Institute of Engineering and Technology, Vizianagaram- 535005, Andhra Pradesh, India. 2. Mr. RITURAJ CHANDRAKAR Lecturer, Mechanical Engineering, NMDC DAV Polytechnic, SAVB Education City, Jawanga, Geedam-494441, Dantewada Districts, Chhattisgarh, India. 3. Dr. AJAY KUMAR GUPTA HOD, Mechanical Engineering Department &amp; Training and placement Head, Shri Rawatpura Sarkar University, Raipur- 492015, Chhattisgarh, India 4. Dr. ABHISHEK JHA Assistant Professor, Department of Mechanical Engineering, Amrita School of Engineering, Chennai-641112, Tamil Nadu, India</p>		
<b>Date of Registration</b>	23/08/2022	
<b>Title</b>	AGRICULTURE DRONE SPRAYER	
<b>Priority NA</b>		





<b>Design Number</b>	379235-001	
<b>Class</b>	02-04	
<b>RELAXO FOOTWEARS LIMITED Aggarwal City Square, Plot No. 10, District Centre, Mangalam Place, Sector-03, Rohini, Delhi-110085, India</b>		
<b>Date of Registration</b>	13/02/2023	
<b>Title</b>	Footwear	
<b>Priority NA</b>		



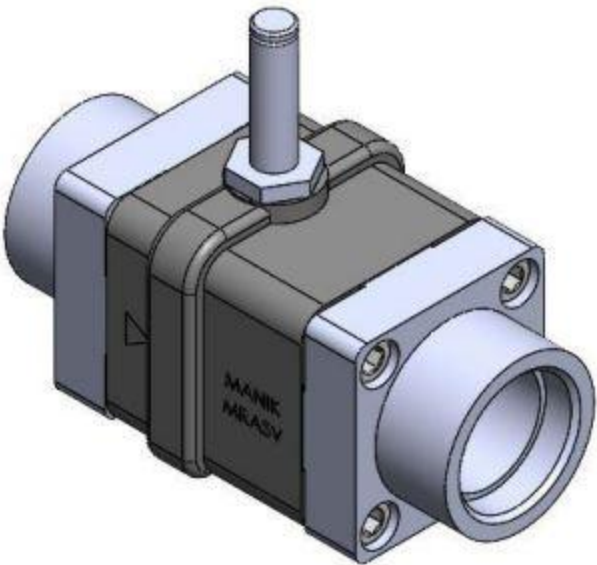

<b>Design Number</b>	378497-001	
<b>Class</b>	15-01	
<b>Futech Machinery Private Limited Khewat No.291/253, Khasra No.320 Killa No.68, Rohad, Bahadurgarh, Haryana 124 507, India.,</b>		
<b>Date of Registration</b>	02/02/2023	
<b>Title</b>	PREFILL CHECK VALVE ASSEMBLY	
<b>Priority NA</b>		
<b>Design Number</b>	358381-001	
<b>Class</b>	21-01	
<b>DEEPAK VATS W-92, CHANDER SHEKHAR AZAD GALI NO-4, BABARPUR, SHAHDARA S.O, EAST DELHI, DELHI - 110032, INDIA</b>		
<b>Date of Registration</b>	11/02/2022	
<b>Title</b>	TOY	
<b>Priority NA</b>		
<b>Design Number</b>	377037-001	
<b>Class</b>	23-03	
<b>Kamalkishor N. Laddha "PADMAREKHA" 26, Vasant Nagar, Jawahar Colony, Trimurti Chowk, Near Saibaba Mandir, Aurangabad - 431005 (Maharashtra)</b>		
<b>Date of Registration</b>	09/01/2023	
<b>Title</b>	WATER HEATER	
<b>Priority NA</b>		

<b>Design Number</b>	360074-001	
<b>Class</b>	07-01	
<b>1.MS. BHAVNA MISTRY SILVER OAK UNIVERSITY CAMPUS, OPP. BHAGWAT VIDYAPITH, S.G ROAD, GOTA, AHMEDABAD – 382481 2. MR. AAKASH MISTRY SILVER OAK UNIVERSITY CAMPUS, OPP. BHAGWAT VIDYAPITH, S.G ROAD, GOTA, AHMEDABAD – 382481</b>		
<b>Date of Registration</b>	07/03/2022	
<b>Title</b>	COFFEE COOKIES MUG	
<b>Priority NA</b>		
<b>Design Number</b>	356806-001	
<b>Class</b>	23-04	
<b>Havells India Limited 904, 9th Floor, Surya Kiran Building, KG Marg, Connaught Place, New Delhi –110001</b>		
<b>Date of Registration</b>	17/01/2022	
<b>Title</b>	CEILING FAN	
<b>Priority NA</b>		
<b>Design Number</b>	378193-001	
<b>Class</b>	24-02	
<b>1.Dr. Anita Soni Professor CSE Department, IES University Bhopal, Madhya Pradesh- 462044, India 2. Dr. Archana Sharma Professor, Electronics and communication department, Technocrats Institute of Technology (Excellence), Bhopal, Madhya Pradesh-462021, India 3. Sandeep Kumar Shukla Assistant professor, EC department, TITE, Bhopal, Madhya Pradesh-462021, India 4. Ms. Chitra Mathankar Assistant Professor, CSE Department, IES University, Bhopal, Madhya Pradesh- 462044, India</b>		
<b>Date of Registration</b>	29/01/2023	
<b>Title</b>	AN IOT BASED COVID DETECTION AND PREVENTION SYSTEM	
<b>Priority NA</b>		

Design Number	378523-001	
Class	23-01	
<b>1. TEJASHREE TEJAS KULKARNI Flat no. 3, Malati Apartments, Girija Society, Kothrud, Pune - 411038, Maharashtra, India 2. PADMANABH SHEKHAR KULKARNI 401, Sindh Society, Baner Road, Aundh, Pune - 411007, Maharashtra, India.</b>		
Date of Registration	02/02/2023	
Title	Solenoid Valve without coil	
Priority NA		

Design Number	376558-001	
Class	12-02	
<b>1. Er. A. B. Madhan Assistant Professor, Department of Robotics &amp; Automation, Sengunthar Engineering College (Autonomous), Tiruchengode - 637205, Namakkal District, Tamil Nadu, India. 2. Dr. T. R. Chinnusamy Dean, Mechanical Sciences, Sengunthar Engineering College (Autonomous), Tiruchengode - 637205, Namakkal District, Tamil Nadu, India. 3. A. Senthilkumar HOD, Department of Robotics &amp; Automation, Sengunthar Engineering College (Autonomous), Tiruchengode - 637205, Namakkal District, Tamil Nadu, India. 4. P. Jagadeeswaran Assistant Professor, Department of Mechanical Engineering, Sengunthar Engineering College (Autonomous), Tiruchengode - 637205, Namakkal District, Tamil Nadu, India.</b>		
Date of Registration	02/01/2023	
Title	VEHICLE BRAKE DRUM CARRYING TROLLEY	
Priority NA		

Design Number	379026-001	
Class	23-01	
<b>Panthera Cleantech Pvt. Ltd. A-8, Safal Profitaire, Corporate Road, Prahladnagar, Ahmedabad- 380015</b>		
Date of Registration	09/02/2023	
Title	WATER SOFTENER	
Priority NA		

<b>Design Number</b>	378170-001	
<b>Class</b>	14-06	
<b>Pavitra Kaur 77A/1 Dilshad Garden, Telephone Exchange Road, Delhi - 95</b>		
<b>Date of Registration</b>	28/01/2023	
<b>Title</b>	Mobile Stand	
<b>Priority NA</b>		

<b>Design Number</b>	352167-001	
<b>Class</b>	02-02	
<b>SABYASACHI CALCUTTA LLP 80/2 Topsia Road (South), Kolkata-700046, West Bengal.</b>		
<b>Date of Registration</b>	27/10/2021	
<b>Title</b>	GARMENT	
<b>Priority NA</b>		

<b>Design Number</b>	378685-001	
<b>Class</b>	08-07	
<b>Godrej &amp; Boyce Mfg Co Ltd Pirojshanagar, Vikhroli (W), Mumbai, Maharashtra, India-400079.</b>		
<b>Date of Registration</b>	03/02/2023	
<b>Title</b>	Lock	
<b>Priority NA</b>		

<b>Design Number</b>	352992-001	
<b>Class</b>	14-05	
<b>Giesecke+Devrient Mobile Security GmbH Prinzregentenstrasse 159 81677 Munich Germany</b>		
<b>Date of Registration</b>	12/11/2021	
<b>Title</b>	STORAGE MEDIA ACCESSORY	
<b>Priority</b>		
Priority Number	Date	Country
001481469-0003	13/05/2021	EUIPO





<b>Design Number</b>	378862-001	
<b>Class</b>	24-01	
<b>1. Mr. Anuroop K B Chief Innovation officer, Indian Institute of Information Technology Kottayam, Kerala 2. Dr. Ragesh G K Assistant Professor, Department of Cyber Security, Indian Institute of Information Technology Kottayam, Kerala 3. Dr. M. Radhakrishnan Registrar, Indian Institute of Information Technology Kottayam, Kerala</b>		
<b>Date of Registration</b>	07/02/2023	
<b>Title</b>	MULTI-PURPOSE CAUTERIZATION TOOL FOR AYURVEDA (SET)	
<b>Priority NA</b>		



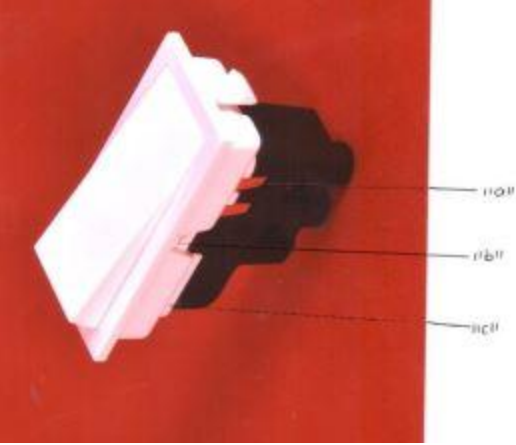

<b>Design Number</b>	378645-001	
<b>Class</b>	26-05	
<b>Light and Shade Electricals Private Limited 11 to 20 and 108 to 114, Luthria House, Sativali Road, Vasai East, District : Palghar, 401208,</b>		
<b>Date of Registration</b>	03/02/2023	
<b>Title</b>	STEP MARKER LIGHT	
<b>Priority NA</b>		



<b>Design Number</b>	376752-001	
<b>Class</b>	15-03	
<b>M/s Ahlawat Agro Industries Ahmeda Chandpur Road, Kulchana, Bijnor, Uttar Pradesh-246729, Proprietor is Prashant Ahlawat</b>		
<b>Date of Registration</b>	05/01/2023	
<b>Title</b>	INTER ROW ROTARY WEEDER	
<b>Priority NA</b>		
<b>Design Number</b>	378656-001	
<b>Class</b>	13-03	
<b>AADINATH INDUSTRIES ., AADINATH AVENUE, GROUND AND FIRST FLOOR, SURVEY NO. 66/2, GAWRAI PADA, BILAL PADA, VASAI (EAST), DIST - PALGHAR</b>		
<b>Date of Registration</b>	04/02/2023	
<b>Title</b>	SWITCH	
<b>Priority NA</b>		
<b>Design Number</b>	359875-001	
<b>Class</b>	14-01	
<b>Mukesh Jeshabhai Bambhaniya 201, FLOOR-GRD, PLOT-29, RUSTOM BUILDING, VEER NARIMAN ROAD, HUTATMA CHOWK, FORT, MUMBAI-400001, INDIA</b>		
<b>Date of Registration</b>	04/03/2022	
<b>Title</b>	Headphone	
<b>Priority NA</b>		



<b>Design Number</b>	360025-001	
<b>Class</b>	06-01	
<b>Godrej &amp; Boyce Mfg. Co. Ltd. Pirojshanagar, Vikhroli (W), Mumbai, Maharashtra, India-400079.</b>		
<b>Date of Registration</b>	07/03/2022	
<b>Title</b>	Chair	
<b>Priority NA</b>		

<b>Design Number</b>	357086-001	
<b>Class</b>	20-01	
<b>PEPSICO, INC. 700 Anderson Hill Road, Purchase, New York 10577, United States of America</b>		
<b>Date of Registration</b>	21/01/2022	
<b>Title</b>	VENDING MACHINE	
<b>Priority</b>		
Priority Number	Date	Country
29/801,619	29/07/2021	U.S.A.

<b>Design Number</b>	361964-001	
<b>Class</b>	12-16	
<b>Ford Global Technologies, LLC 330 Town Center Drive, Suite 800, Dearborn Michigan, 48126, United States of America</b>		
<b>Date of Registration</b>	05/04/2022	
<b>Title</b>	Windshield	
<b>Priority</b>		
Priority Number	Date	Country
402021100966.3	20/10/2021	Germany

<b>Design Number</b>	360159-001		
<b>Class</b>	23-04		
<b>MITSUBISHI HEAVY INDUSTRIES THERMAL SYSTEMS, LTD. 2-3, Marunouchi 3-Chome, Chiyoda-ku, Tokyo, 100-8332, Japan.</b>			
<b>Date of Registration</b>	09/03/2022		
<b>Title</b>	WALL-MOUNTED AIR CONDITIONER		
<b>Priority</b>			
Priority Number	Date	Country	
2021-019960	15/09/2021	Japan	
<b>Design Number</b>	378458-001		
<b>Class</b>	07-02		
<b>Ouseph P.D Ouseph P.D, Peechanatt House, Gandhi Nagar II, Kothamangalam P.O, Pin code: 686691, Ernakulam Distri</b>			
<b>Date of Registration</b>	02/02/2023		
<b>Title</b>	LID FOR KITCHEN UTENSILS		
<b>Priority NA</b>			
<b>Design Number</b>	374244-001		
<b>Class</b>	10-04		
<b>1.K RAMAKRISHNAN COLLEGE OF TECHNOLOGY KARIYAMANICKAM ROAD, SAMAYAPURAM, TRICHY-621112, TAMILNADU, INDIA 2. A RAHAMATHULLA DEPARTMENT OF MECHANICAL ENGINEERING, K RAMAKRISHNAN COLLEGE OF TECHNOLOGY, TRICHY-621112, TAMILNADU, INDIA 3. B SURESH KUMAR DEPARTMENT OF MECHANICAL ENGINEERING, K RAMAKRISHNAN COLLEGE OF TECHNOLOGY, TRICHY-621112, TAMILNADU, INDIA 4. S SARAVANAN \DEPARTMENT OF MECHANICAL ENGINEERING, K RAMAKRISHNAN COLLEGE OF TECHNOLOGY, TRICHY-621112, TAMILNADU, INDIA , et al.</b>			
<b>Date of Registration</b>	16/11/2022		
<b>Title</b>	ANIMAL TRACKIING STRAP USING RFID		
<b>Priority NA</b>			

<b>Design Number</b>	379437-001	
<b>Class</b>	12-11	
<b>HONDA MOTOR CO., LTD. 1-1, Minami-Aoyama 2-Chome, Minato-ku, Tokyo, 107-8556 Japan</b>		
<b>Date of Registration</b>	16/02/2023	
<b>Title</b>	MOTORCYCLE	
<b>Priority</b>		
<b>Priority Number</b>	<b>Date</b>	<b>Country</b>
2022-017832	22/08/2022	Japan









<b>Design Number</b>	379076-001	
<b>Class</b>	24-01	
<b>NISCOMED MEDICAL DEVICES PVT LTD 37, RAJASTHANI UDYOG NAGAR, NORTH DELHI- 110033</b>		
<b>Date of Registration</b>	10/02/2023	
<b>Title</b>	ECG MACHINE	
<b>Priority NA</b>		

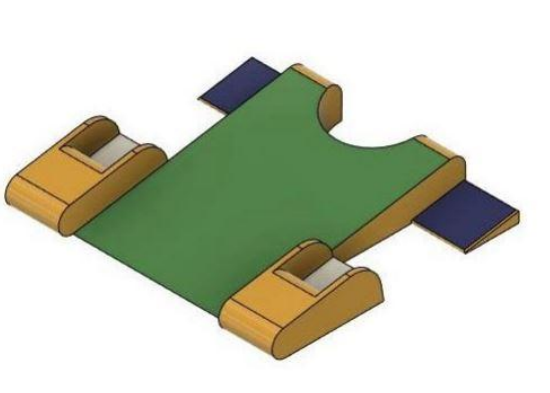

<b>Design Number</b>	378164-001	
<b>Class</b>	12-16	
<b>HARINDER PAL BHOGAL H. No. 74-F, Sun View Enclave, Ayali Kalan, LUDHIANA – 142027 (PUNJAB) INDIA</b>		
<b>Date of Registration</b>	28/01/2023	
<b>Title</b>	LOCKING BODY FOR TOWING ASSEMBLY	
<b>Priority NA</b>		



<b>Design Number</b>	379221-001	
<b>Class</b>	11-01	
<b>APALA 6, Hauz Khas Village, New Delhi-110016, India</b>		
<b>Date of Registration</b>	13/02/2023	
<b>Title</b>	NECKLACE	
<b>Priority NA</b>		
<b>Design Number</b>	378453-001	
<b>Class</b>	11-05	
<b>KANTA DHANWANI PLOT. 62, SANT LEELA SHAH COLONY, DHOLA BHATA ROAD, AJMER, RAJASTHAN-305001</b>		
<b>Date of Registration</b>	01/02/2023	
<b>Title</b>	FESTIVE DECORATIONS	
<b>Priority NA</b>		
<b>Design Number</b>	379629-001	
<b>Class</b>	14-06	
<b>Genminds Skill Trainings and Technological Services Private Limited 29-922/1, Besides Khasim Garu House, Vinukonda, Guntur, Andhra Pradesh, India,522647, India</b>		
<b>Date of Registration</b>	20/02/2023	
<b>Title</b>	LAPTOP STAND	
<b>Priority NA</b>		

<b>Design Number</b>	359466-001		
<b>Class</b>	07-09		
<b>NAAD ENTERPRISES KH NO.93/9, GALI NO -1 LEFT SIDE, UDHYOG NAGAR, MUNDKA INDUSTRIAL AREA, New Delhi-110041, India</b>			
<b>Date of Registration</b>	26/02/2022		
<b>Title</b>	FLAIR (UTENSIL RACK)		
<b>Priority NA</b>			
<b>Design Number</b>	335267-001		
<b>Class</b>	09-01		
<b>UNILEVER GLOBAL IP LIMITED Port Sunlight, Wirral, Merseyside CH62 42D United Kingdom</b>			
<b>Date of Registration</b>	16/11/2020		
<b>Title</b>	BOTTLES FOR LIQUIDS		
<b>Priority</b>			
Priority Number	Date	Country	
008177398-0002	21/09/2020	EUIPO	
<b>Design Number</b>	338530-001		
<b>Class</b>	13-03		
<b>DANFOSS POWER ELECTRONICS A/S Ulsnæs 1 DK-6300 Gråsten Denmark</b>			
<b>Date of Registration</b>	03/02/2021		
<b>Title</b>	FREQUENCY CONVERTER		
<b>Priority</b>			
Priority Number	Date	Country	
008074363-0012	04/08/2020	EUIPO	

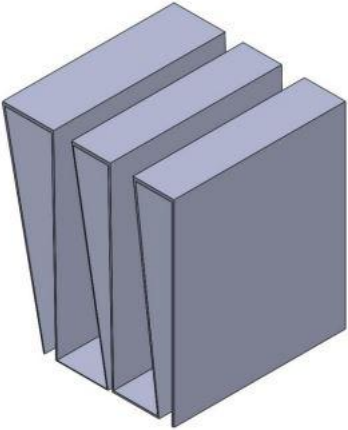
<b>Design Number</b>	365267-001	
<b>Class</b>	19-02	
<b>1. Chandigarh University National Highway 95, Chandigarh-Ludhiana Highway, Mohali, Punjab-140413, India 2. Sanjeet Singh UCRD, Chandigarh University, National Highway 95, Chandigarh-Ludhiana Highway, Mohali, Punjab-140413, India 3. Raman Kumar Department of Mechanical Engineering, Chandigarh University, National Highway 95, Chandigarh-Ludhiana Highway, Mohali, Punjab-140413, India</b>		
<b>Date of Registration</b>	01/06/2022	
<b>Title</b>	PAPER CLIP	
<b>Priority NA</b>		

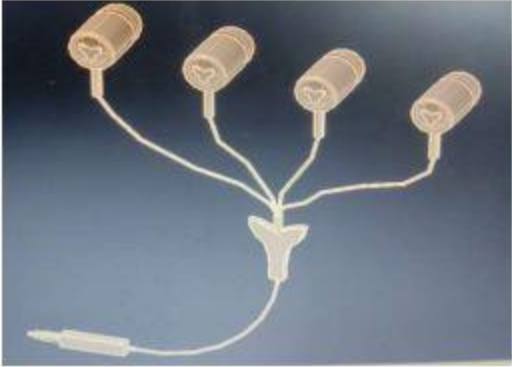
<b>Design Number</b>	378500-001	
<b>Class</b>	14-01	
<b>1. Chaitanya Vijay Joshi Swapnapurti bunglow, Plot No.2, Near Ambar Apartment, Bankar Mala, Nashik Puna Road- Nashik- 422006 2. Amruta Uttamrao Jadhav Flat no.2, Tatwamasi Apartment, Makhmalabad Road, Panchavati , Kranti nagar, Nashik-422003 3. Afroz Mohammad Rafik Shaikh, A/27, Ugandhara Society, Aditya Nagar, Patnadevi Road, Chalisgaon -424101.</b>		
<b>Date of Registration</b>	02/02/2023	
<b>Title</b>	EARPHONE	
<b>Priority NA</b>		

<b>Design Number</b>	376611-001	
<b>Class</b>	11-02	
<b>MICHAEL ARAM INDIA PRIVATE LIMITED A-41,SECTOR -80,PHASE-II,NOIDA-201305,U.P.INDIA</b>		
<b>Date of Registration</b>	03/01/2023	
<b>Title</b>	VASE	
<b>Priority NA</b>		

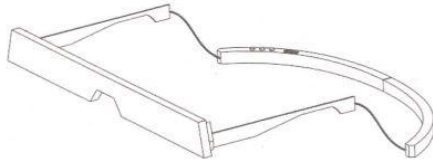
<b>Design Number</b>	378539-001	
<b>Class</b>	16-06	
<b>1. Mrs. G. S. Geethamani Associate Professor, Information Technology, Hindusthan College of Arts and Science, Coimbatore, Tamilnadu 2. Dr. K. Mythili Gnanapriya Associate Professor, Mathematics, Nehru Arts and Science College, Coimbatore, Tamilnadu 3. Dr. D. Anitha Associate Professor, Computer Science, Sri Ramakrishna College of Arts &amp; Science for Women, Coimbatore, Tamilnadu 4. Dr. K. Juliana Gnanaselvi Associate Professor, Computer Science, Rathinam College of Arts and Science, Coimbatore, Tamilnadu , et al.</b>		
<b>Date of Registration</b>	03/02/2023	
<b>Title</b>	Smart computing goggle	
<b>Priority NA</b>		

<b>Design Number</b>	378506-001
<b>Class</b>	23-01
<b>1. TEJASHREE TEJAS KULKARNI Flat no. 3, Malati Apartments, Girija Society, Kothrud, Pune - 411038, Maharashtra, India 2. PADMANABH SHEKHAR KULKARNI 401, Sindh Society, Baner Road, Aundh, Pune - 411007, Maharashtra, India.</b>	
<b>Date of Registration</b>	02/02/2023
<b>Title</b>	CAPACITY LOADING VALVE FOR COMPRESSOR WITH COIL
<b>Priority NA</b>	

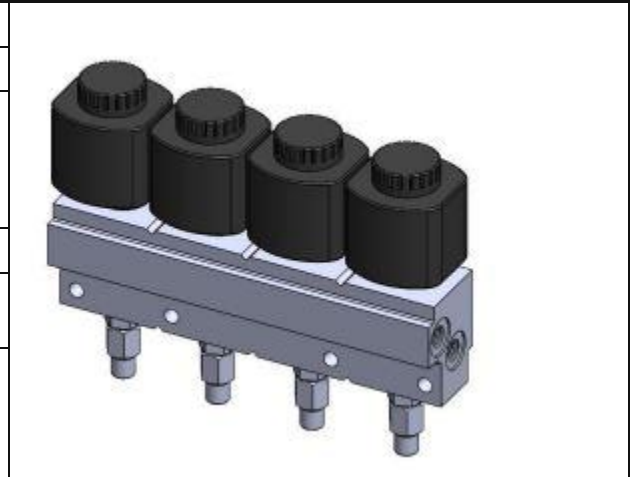

<b>Design Number</b>	368153-001
<b>Class</b>	12-11
<b>CUTE CYCLES PVT. LTD. K-41-44, PHASE-VII, FOCAL POINT, LUDHIANA-141 010 (PUNJAB) INDIA</b>	
<b>Date of Registration</b>	22/07/2022
<b>Title</b>	SEALED BEARING MTB FRONT WITH QUICK RELEASE
<b>Priority NA</b>	



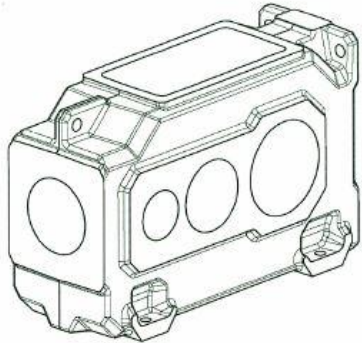

<b>Design Number</b>	378673-001	
<b>Class</b>	23-04	
<b>RJP TECHNOLOGIES PRIVATE LIMITED SY NO 509/1/2, PLOT NO 71, 72 AND 73 APPAREL EXPORT PARK, GUNDLAPOCHAMPALLY, HYDERABAD – 500014</b>		
<b>Date of Registration</b>	04/02/2023	
<b>Title</b>	Ceiling Fan	
<b>Priority NA</b>		



<b>Design Number</b>	375540-001		
<b>Class</b>	12-16		
<b>FLENDER GmbH ALFRED-FLENDER-STRASSE 77, DE-46395 BOCHOLT, GERMANY</b>			
<b>Date of Registration</b>	13/12/2022		
<b>Title</b>	GEAR BOX		
<b>Priority</b>			
<b>Priority Number</b>	<b>Date</b>	<b>Country</b>	
009062136	15/06/2022	EUIPO	

<b>Design Number</b>	376619-002		
<b>Class</b>	11-02		
<b>Michael Aram India Private Limited A-41, Sector - 80, Phase - II, Noida - 201305, U.P., India</b>			
<b>Date of Registration</b>	03/01/2023		
<b>Title</b>	VASE.		
<b>Priority NA</b>			





Design Number	343235-001	
Class	15-09	
1. Saleemsab Doddamani #566/1P, 2nd Stage, 2nd Cross, Lanin Nagar, Nituvalli New Extn Davangere, Karnataka-577008, India 2. Rajesh A M #566/1P, 2nd Stage, 2nd Cross, Lanin Nagar, Nituvalli New Extn Davangere, Karnataka-577008, India		
Date of Registration	10/05/2021	
Title	METAL CASTING MOLD BOX	
Priority NA		
Design Number	337772-001	
Class	09-05	
Sharas Enterprise 2/105c Vinayagar Kovil street, nadupalayam road near elementary school, Pattanam pudur, Coimbatore 641016		
Date of Registration	21/01/2021	
Title	Bags	
Priority NA		
Design Number	376549-001	
Class	15-99	
1. Sri Manakula Vinayagar Engineering College Madagadipet, Puducherry - 605 107, India. 2. Dr. V. S. K. Venkatachalapathy Director cum Principal, Sri Manakula Vinayagar Engineering College, Madagadipet, Puducherry - 605 107, India. 3. Mr. A. Giriprasath Assistant Professor, Department of Mechanical Engineering, Sri Manakula Vinayagar Engineering College, Madagadipet, Puducherry - 605107, India 4. D. Manoj Department of Mechanical Engineering, Sri Manakula Vinayagar Engineering College, Madagadipet, Puducherry - 605 107, India. , et al.		
Date of Registration	02/01/2023	
Title	PLASTIC CRUSHING MACHINE	
Priority NA		

<b>Design Number</b>	324479-001	
<b>Class</b>	24-04	
<b>OMPRAKASH GARG MANMANDIR, PLOT # 13, GULMOHOR COLONY, BEHIND KULKARNI MANGAL KARYALAY, ANAND NAGAR, NASHIK ROAD, NA</b>		
<b>Date of Registration</b>	07/12/2019	
<b>Title</b>	CONDOM	
<b>Priority NA</b>		
<b>Design Number</b>	378825-001	
<b>Class</b>	09-01	
<b>JOLLY CONTAINERS Survey No. 739/740, Kalaria, Dabhel, Nani Daman - 396 210, India.</b>		
<b>Date of Registration</b>	07/02/2023	
<b>Title</b>	PET INNER LOCK CONTAINER WITH LID	
<b>Priority NA</b>		
<b>Design Number</b>	380353-001	
<b>Class</b>	24-02	
<b>1. Dr. Gampa Vijay Kumar Professor, Department of Pharmacy, KGR Institute of Technology and Management, Hyderabad, Telangana-501301, India 2. Dr. Shaik Harun Rasheed Professor &amp; Associate Director, Department of Pharmacy, Gurunanak institutions Technical Campus-School of Pharmacy, Khanapur, Ranga Reddy, Ibrahimpatnam, Telangana- 501506, India 3. Dr. Mudduluru Niranjan Babu Principal &amp; Professor, Department of Pharmacy, Seven Hills College of Pharmacy, Tirupati – 517561, Andhra Pradesh, India</b>		
<b>Date of Registration</b>	28/02/2023	
<b>Title</b>	PULSE OXIMETER	
<b>Priority NA</b>		

<b>Design Number</b>	379267-001	
<b>Class</b>	24-01	
<b>1. Dr. Prashant Upadhyay Professor and Head, School of Pharmaceutical Sciences, IFTM University, Moradabad, Uttar Pradesh - 244102, India 2. Gayatri Rajesh Katole Nagpur college of pharmacy, Wanadongri, NAGPUR, Maharashtra - 441110, India 3. Dr. Swarupananda Mukherjee NSHM Knowledge Campus, Kolkata - Group of Institutions, 124, B. L Saha Road, Kolkata, West Bengal - 700053, India 4. Dr. Ashutosh Kumar Yadav Tirupati College of Engineering Lucknow, 99/100, Hans Nagar Colony Para, Lucknow, Uttar Pradesh - 226301, India , et al.</b>		
<b>Date of Registration</b>	14/02/2023	
<b>Title</b>	STEAM INHALER	
<b>Priority NA</b>		
<b>Design Number</b>	362052-001	
<b>Class</b>	28-03	
<b>LOOMANTHA ENTERPRISES PRIVATE LIMITED A-23, BLOCK A, RAMA PARK, UTTAM NAGAR, DELHI-110059</b>		
<b>Date of Registration</b>	06/04/2022	
<b>Title</b>	HAIR TRIMMER	
<b>Priority NA</b>		
<b>Design Number</b>	329694-001	
<b>Class</b>	02-02	
<b>Lovely Professional University Lovely Professional University Jalandhar Delhi GT road phagwara-144411</b>		
<b>Date of Registration</b>	30/05/2020	
<b>Title</b>	MOUNTED FLORET ON T Shirt	
<b>Priority NA</b>		

Design Number	363702-001	
Class	12-16	
Advance Plastic Industries Station Road, Dhandari Kalan, Ludhiana, Punjab, India		
Date of Registration	05/05/2022	
Title	HANDEL STEM FOR CYCLES	
Priority NA		

Design Number	361339-001	
Class	19-06	
1. CHITKARA UNIVERSITY (PUNJAB) CHITKARA UNIVERSITY, CHANDIGARH-PATIALA, NATIONAL HIGHWAY, VILLAGE JHANSLA, RAJPURA, PUNJAB - 140401, INDIA. 2. CHITKARA INNOVATION INCUBATOR FOUNDATION SCO: 160-161, SECTOR -9C, MADHYA MARG, CHANDIGARH- 160009, INDIA. 3. GARG NANDINI STUDENT, CHITKARA BUSINESS SCHOOL, CHITKARA UNIVERSITY, PUNJAB, INDIA. 4. RAJNI BANSAL ASSOCIATE PROFESSOR, CHITKARA BUSINESS SCHOOL, CHITKARA UNIVERSITY, PUNJAB, INDIA,		
Date of Registration	28/03/2022	
Title	PEN WITH PENCIL	
Priority NA		

Design Number	376757-001	
Class	31-00	
M/S Telewood E- 13, Sector- 3, DSIIDC, Bawana Industrial Area, North East Delhi, Delhi- 110039, India, Proprietor is Ashish Garg		
Date of Registration	05/01/2023	
Title	BASE OF MIXER.	
Priority NA		

<b>Design Number</b>	379313-001	
<b>Class</b>	02-04	
<b>Nexgen Footwears Pvt. Ltd. H-42, Udyog Nagar, Industrial Area, Delhi- 110041</b>		
<b>Date of Registration</b>	15/02/2023	
<b>Title</b>	SHOE SOLE	
<b>Priority NA</b>		

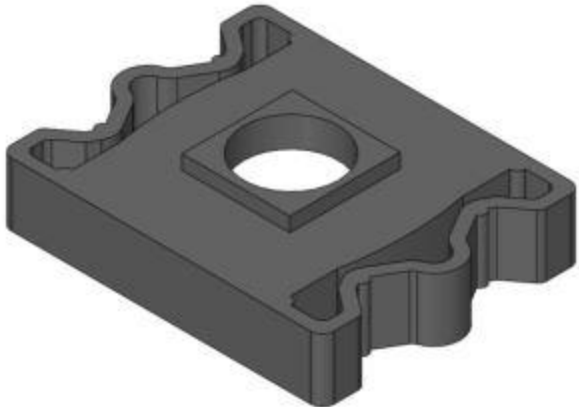
<b>Design Number</b>	379829-001	
<b>Class</b>	06-06	
<b>MBM (India) Private Limited No. G 49, ST 134, Vallam Vadagal, SIPCOT, Sriperumbudur, Kancheepuram - 602105, Tamil Nadu, India</b>		
<b>Date of Registration</b>	21/02/2023	
<b>Title</b>	Chair armrest handle sliding piece	
<b>Priority NA</b>		

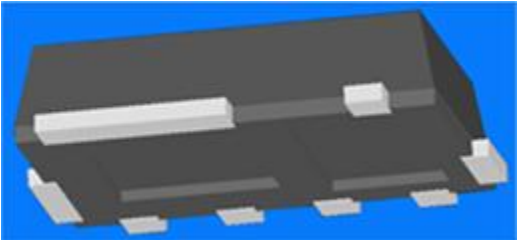
<b>Design Number</b>	328570-001	
<b>Class</b>	09-03	
<b>China Chippacking Technology Co., Ltd., 301-2,1# Factory Bldgs,NO.250,West Pinglong Rd,Fucheng'ao Community,Pinghu Sub-dist,Longgang Dist,Shenzhen City,Guangdong Province, China</b>		
<b>Date of Registration</b>	24/03/2020	
<b>Title</b>	improved Integrated Circuit Packaging Assembly	
<b>Priority</b>		
<b>Priority Number</b>	<b>Date</b>	<b>Country</b>
201930539497.8	29/09/2019	China

<b>Design Number</b>	376560-001	
<b>Class</b>	07-02	
<b>Sumit Kishan Sharma E-109, Sector-23 Sanjay Colony, Welcome Industrial Complex, Faridabad - 121001</b>		
<b>Date of Registration</b>	02/01/2023	
<b>Title</b>	GAS BURNER	
<b>Priority NA</b>		

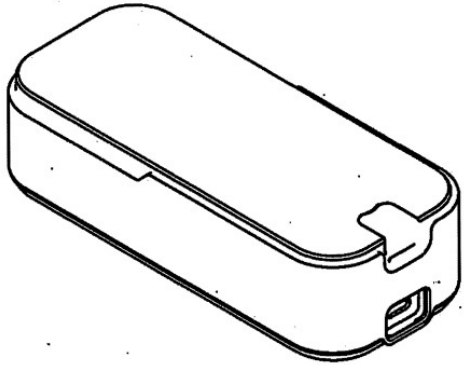

<b>Design Number</b>	312255	
<b>Class</b>	24-01	
<b>Oxford Nanopore Technologies Limited Gosling Building, Edmund Halley Road, Oxford Science Park, Oxford OX4 4DQ, United Kingdom</b>		
<b>Date of Registration</b>	21/11/2018	
<b>Title</b>	Analyses Device for processing of biological samples	
<b>Priority</b>		
<b>Priority Number</b>	<b>Date</b>	<b>Country</b>
6035715	22/05/2018	U.K.

<b>Design Number</b>	376608-003	
<b>Class</b>	07-01	
<b>MICHAEL ARAM INDIA PRIVATE LIMITED A-41,SECTOR - 80,PHASE-II,NOIDA-201305,U.P.INDIA</b>		
<b>Date of Registration</b>	03/01/2023	
<b>Title</b>	CHEESE BOARD.	
<b>Priority NA</b>		

<b>Design Number</b>	335494-001	
<b>Class</b>	10-05	
<b>Sai Tools Private Limited W/9B, MIDC, Additional Ambernath, Anand Nagar, Ambernath (East), Thane-401506, Maharashtra, India</b>		
<b>Date of Registration</b>	24/11/2020	
<b>Title</b>	RETRACTING BYPASS CONDUCTOR ASSEMBLY (MACHINE)	
<b>Priority NA</b>		

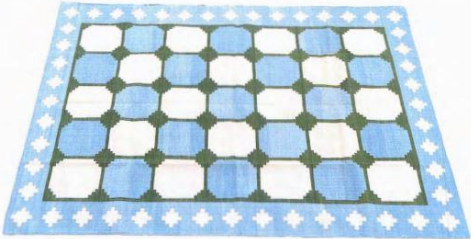
<b>Design Number</b>	334593-001	
<b>Class</b>	13-01	
<b>SU-VASTIKA SYSTEMS PRIVATE LIMITED SF-06, SECOND FLOOR, JMD REGENT PLAZA, VILLAGE SIKANDERPUR GHOSI, GURGAON-122002</b>		
<b>Date of Registration</b>	24/10/2020	
<b>Title</b>	UPS	
<b>Priority NA</b>		

<b>Design Number</b>	377471-003	
<b>Class</b>	06-11	
<b>Amit Gupta Mohini Creations, Plot No. 4, Ganesh Vihar, Keshopura, Bhankrota, Jaipur, Rajasthan-302026, India</b>		
<b>Date of Registration</b>	16/01/2023	
<b>Title</b>	RUG	
<b>Priority NA</b>		

<b>Design Number</b>	339208-001	
<b>Class</b>	10-05	
<b>SAMEER MEMON 'SHRAM SAFALYA', NEXT TO THORAT BUILDING, NEAR RAILWAY CROSSING, SAYYAD NAGAR, HADAPSAR, PUNE, 411028 MAHARASHTRA-INDIA</b>		
<b>Date of Registration</b>	16/02/2021	
<b>Title</b>	DIGITAL BATTERY TESTER	
<b>Priority NA</b>		
<b>Design Number</b>	378917-001	
<b>Class</b>	24-99	
<b>1. Dr. Ashish Kumar Mourya Department of Computer Science, GNIOT INSTITUTE OF PROFESSIONAL STUDIES, Uttar Pradesh- 201310, India 2. Dr. Seema Rani AIIT, Amity University, Noida, Uttar Pradesh- 201313, India 3. Dr. Sudeshna Chakraborty Professor, School of Computing Science and Engineering, Galgotias university, Uttar Pradesh-201310, India 4. Dr. Rajit Nair Assistant Professor, VIT Bhopal University, Bhopal, Madhya Pradesh - 466114, India</b>		
<b>Date of Registration</b>	08/02/2023	
<b>Title</b>	MACHINE LEARNING VOICE ASSISTED MEDICAL DEVICE FOR DEAF PEOPLE	
<b>Priority NA</b>		
<b>Design Number</b>	379165-001	
<b>Class</b>	20-01	
<b>FINAARA TECHNOLOGIES PRIVATE LIMITED 42/81 TTK Road, Alwarpet, Chennai - 600018, Tamil Nadu, India</b>		
<b>Date of Registration</b>	13/02/2023	
<b>Title</b>	Device for Performing Financial Transactions	
<b>Priority NA</b>		

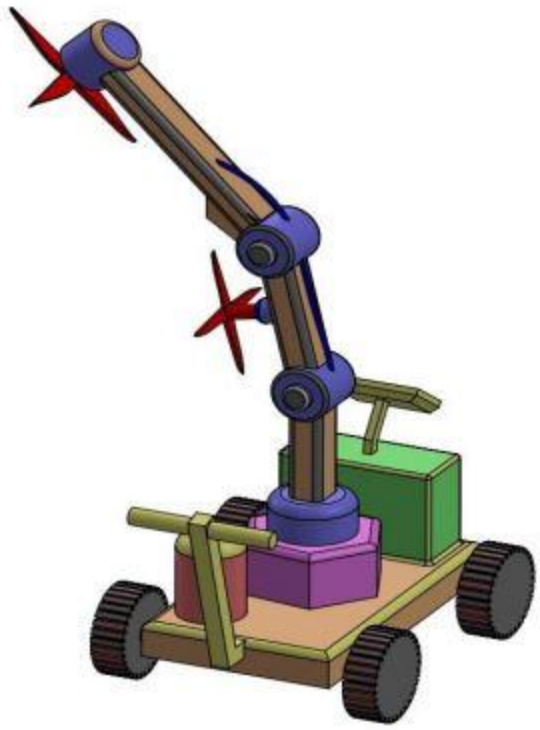

Design Number	379570-001	
Class	08-03	
<b>1. Dr. Vikash Kumar Assistant Professor, Department of Mechanical Engineering, MANIT Bhopal, MP 462003 2. Dr. B L Raju Professor &amp; Principal, ACE Engineering College, Ankushapur, Ghatkesar, Hyderabad – 501301, Telangana-India 3. Shaha Alam Assistant Professor, Malla Reddy College of Engineering, Maisammaguda, Hyderabad-100 4. Mr. Rajesh Durgam Assistant Professor, Malla Reddy College of Engineering, Maisammaguda, Hyderabad-100</b>		
Date of Registration	17/02/2023	
Title	AUTOMATIC TREE SHAPER WITH ADJUSTABLE BLADES	
Priority NA		

Design Number	360260-001	
Class	06-03	
<b>Mr. Manish Bhupatbhai Munjapara 11, Avadh Viceroy, Sarthana Jakatnaka, Surat, Gujarat, 395006, India</b>		
Date of Registration	10/03/2022	
Title	LAPTOP STAND	
Priority NA		

Design Number	343182-001	
Class	23-04	
<b>1. Jigneshkumar Ramniklal Vala C18, Jaynidhi Township, Diwalipura, Old Padra Road, Vadodara - 390007, Gujarat, India 2. Dr. Hitesh Navinchandra Panchal 27, Abhinav Bungalows, Behind Wide Angle Cinema, Mahesana 384002, Gujarat, India 3. Dr. D. K. Patel Government Engineering College, At &amp; Post. Katpur, Patan - 384265, Gujarat, India</b>		
Date of Registration	08/05/2021	
Title	Low Speed Axial Flow Fan	
Priority NA		

<b>Design Number</b>	328446-001	
<b>Class</b>	14-02	
<b>Advanced New Technologies Co.,Ltd. Cayman Corporate Centre, 27 Hospital Road, George Town, Grand Cayman KYI-9008, Cayman Islands., Nationality: Cayman Islands;</b>		
<b>Date of Registration</b>	20/03/2020	
<b>Title</b>	PAYMENT MACHINE	
<b>Priority</b>		
Priority Number	Date	Country
CN 201930521041.9	23/09/2019	China

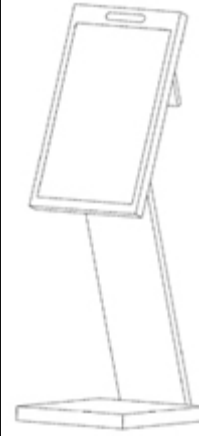



<b>Design Number</b>	379463-001
<b>Class</b>	21-01
<b>1. Himanshu A. Deshmukh A/ 602 Gera Isle Royale, Bavdhan, Pune – 411021, Maharashtra, India 2. Harshal A. Deshmukh A/ 602 Gera Isle Royale, Bavdhan, Pune – 411021, Maharashtra, India 3. Suhasini Paul A-603, 43 Privet Drive, Balewadi, Pune – 411045, Maharashtra, India 4. Sandip Paul A-603, 43 Privet Drive, Balewadi, Pune – 411045, Maharashtra, India</b>	
<b>Date of Registration</b>	16/02/2023
<b>Title</b>	TOY
<b>Priority NA</b>	



<b>Design Number</b>	378824-001
<b>Class</b>	02-04
<b>M/S ARV FOOTWEAR PRIVATE LIMITED. PLOT NO. D-9, KHEWAT NO.129/110, KHATA NO.198, KILLA NO.31/4 8-0, 5/2 1-0, 7/1/2 0-18, M.I.E, PART-A, BAHADURGARH, JHAJJAR, HARYANA-124507.</b>	
<b>Date of Registration</b>	07/02/2023
<b>Title</b>	FOOTWEAR
<b>Priority NA</b>	



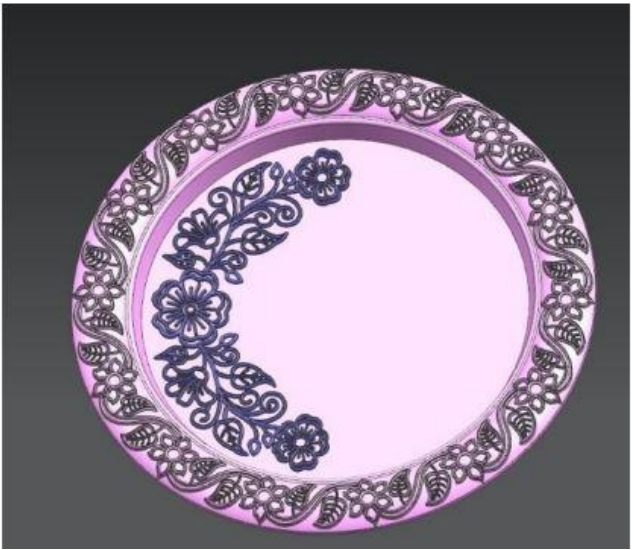

<b>Design Number</b>	376618-004	
<b>Class</b>	07-01	
<b>Michael Aram India Private Limited A-41, Sector - 80, Phase - II, Noida - 201305, U.P., India</b>		
<b>Date of Registration</b>	03/01/2023	
<b>Title</b>	DISH	
<b>Priority NA</b>		
<b>Design Number</b>	379082-001	
<b>Class</b>	08-05	
1.Dhaanish Ahmed College Of Engineering Dhaanish Nagar Vanchuvancherry Padappai, Near Tambaram, Chennai, Tamil Nadu 601301 2. Dr.K.Bogeshwaran Associate Professor, Dept of Petro, Dhaanish Ahmed College Of Engineering, Dhaanish Nagar Vanchuvancherry Padappai, Near Tambaram, Chennai, Tamil Nadu 601301 3. Mrs.A.T.Ashmi Christus Associate Professor, ECE, Dhaanish Ahmed College Of Engineering, Dhaanish Nagar Vanchuvancherry Padappai, Near Tambaram, Chennai, Tamil Nadu 601301 4. Mrs. G.Sonia Gnanamalar Associate Professor, S&H, Dhaanish Ahmed College Of Engineering, Dhaanish Nagar Vanchuvancherry Padappai, Near Tambaram, Chennai, Tamil Nadu 601301, et al.		
<b>Date of Registration</b>	10/02/2023	
<b>Title</b>	TYRE INFLATOR	
<b>Priority NA</b>		
<b>Design Number</b>	363899-001	
<b>Class</b>	07-01	
<b>Sanat Valchand Jain C-1605, Kanakia Levels, Rani Sati Marg, Kathiyawadi Chowk, Malad East, Mumbai - 400 097</b>		
<b>Date of Registration</b>	08/05/2022	
<b>Title</b>	Dasvanti Flower Haldi-Kumkum Plate	
<b>Priority NA</b>		

<b>Design Number</b>	364174-001	
<b>Class</b>	12-16	
<b>Case New Holland Construction Equipment (India) Private Limited Level- 4, Rectangle- 1, D-4, District Center, Commercial Complex, Saket, New Delhi – 110017</b>		
<b>Date of Registration</b>	13/05/2022	
<b>Title</b>	“COVER FOR STABILIZER CYLINDER OF A TRACTOR LOADER BACKHOE	
<b>Priority NA</b>		
<b>Design Number</b>	379739-001	
<b>Class</b>	02-02	
<b>SABYASACHI CALCUTTA LLP 80/2 Topsia Road (South), Kolkata-700046, West Bengal.</b>		
<b>Date of Registration</b>	20/02/2023	
<b>Title</b>	GARMENT	
<b>Priority NA</b>		
<b>Design Number</b>	379568-001	
<b>Class</b>	24-04	
<b>1. Dr. Laxman Vijapur Associate Professor, Department of Pharmaceutics, BVVS Hanagal Shri Kumareshwar College of Pharmacy, Bagalkot-587101 Karnataka. 2. Dr. Karthickeyan Krishnan Professor and Head, Department of Pharmacy Practice, School of Pharmaceutical Sciences, Vels Institute of Science, Technology and Advanced Studies (VISTAS), Pallavaram, Chennai 600117, Tamil Nadu, India. 3. Dr. Farhad F Mehta Assistant Professor C, School of Pharmaceutical sciences, University Teaching Department, Rajiv Gandhi Prodyogiki Vishvidyalya-462033 University of Technology of Madhya Pradesh Bhopal. 4. Mr. Pradeep Kumar Choda M. Pharm., (PhD) Assistant Professor, Department of Pharmacology, Teegala Krishna Reddy College of Pharmacy, affiliated to JNTUH, Hyderabad, Telangana state. Pin: 500097. , et al.</b>		
<b>Date of Registration</b>	17/02/2023	
<b>Title</b>	PORTABLE STEAM INHALER	
<b>Priority NA</b>		

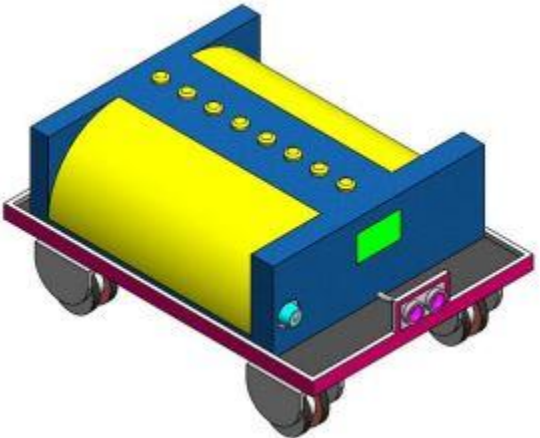
<b>Design Number</b>	358786-001	
<b>Class</b>	13-03	
<b>Devendrasinh Gulabsinh Rajput Plot No.-24, Nr. Ekveera High School, Sharda Nagar, Deopur, Dhule M.S. India Pin 424002</b>		
<b>Date of Registration</b>	18/02/2022	
<b>Title</b>	DEVICE FOR CONTROLLING STREET LAMP	
<b>Priority NA</b>		

<b>Design Number</b>	378952-001	
<b>Class</b>	10-05	
<b>1. Dr.A.Shunmugalatha Professor &amp; Dean (Academics), Department of Electrical and Electronics Engineering, Velammal College of Engineering and Technology, Madurai-625009, Tamil Nadu, India. 2. Dr.T.Grace Shalini Assistant Professor, Department of Computer Science and Engineering, Velammal College of Engineering and Technology, Madurai-625009, Tamil Nadu, India. 3. Mrs.R.Saranya Assistant Professor, Department of Electrical and Electronics Engineering, Velammal College of Engineering and Technology, Madurai-625009, Tamil Nadu, India 4. Mrs.M.Devaki Assistant Professor, Department of Electrical and Electronics Engineering, Velammal College of Engineering and Technology, Madurai-625009, Tamil Nadu, India. , et al.</b>		
<b>Date of Registration</b>	09/02/2023	
<b>Title</b>	IoT based Automated Rail Track Inspection Trolley	
<b>Priority NA</b>		

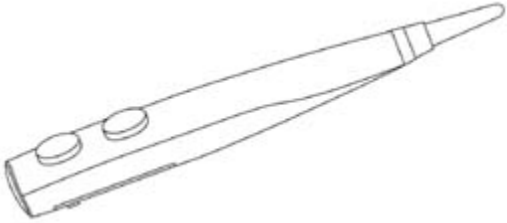
<b>Design Number</b>	361125-009	
<b>Class</b>	07-01	
<b>Michael Aram India Private Limited A-41, Sector - 80, Phase - II, Noida - 201305, U.P., India</b>		
<b>Date of Registration</b>	24/03/2022	
<b>Title</b>	FRUIT BOWL	
<b>Priority NA</b>		

<b>Design Number</b>	346002-001		
<b>Class</b>	24-02		
<b>ActivCell Group AG Luzernerstrasse 20, 6295 Mosen, Switzerland</b>			
<b>Date of Registration</b>	09/07/2021		
<b>Title</b>	HIGH-FREQUENCY THERAPY DEVICE		
<b>Priority</b>			
<b>Priority Number</b>	<b>Date</b>	<b>Country</b>	
145798	18/01/2021	Switzerland	
<b>Design Number</b>	375198-011		
<b>Class</b>	11-01		
<b>Aulyra Design Private Limited 3rd floor, Plot No. 3807, Phase 4, Chakkarpur, Gurugram, Haryana – 122001</b>			
<b>Date of Registration</b>	07/12/2022		
<b>Title</b>	Ring		
<b>Priority NA</b>			
<b>Design Number</b>	379528-001		
<b>Class</b>	02-02		
<b>SABYASACHI CALCUTTA LLP 80/2 Topsia Road (South), Kolkata-700046, West Bengal.</b>			
<b>Date of Registration</b>	16/02/2023		
<b>Title</b>	GARMENT SET		
<b>Priority NA</b>			

<b>Design Number</b>	355155-001	
<b>Class</b>	10-02	
<b>Daniel Wellington AB Vasagatan 12 111 20 STOCKHOLM Sweden</b>		
<b>Date of Registration</b>	20/12/2021	
<b>Title</b>	Wrist Watch	
<b>Priority</b>		
Priority Number	Date	Country
008604185	06/07/2021	EUIPO

  

<b>Design Number</b>	368668-001	
<b>Class</b>	14-02	
1. R MUTHUMINAL R MUTHUMINAL, SNS COLLEGE OF TECHNOLOGY, SNS KALVI NAGAR, SATHY MAIN ROAD, VAZHIYAMPALAYAM PIRIVU, COIMBATORE-641035 2. R MOHANA PRIYA R MOHANA PRIYA, SNS COLLEGE OF TECHNOLOGY, SNS KALVI NAGAR, SATHY MAIN ROAD, VAZHIYAMPALAYAM PIRIVU, COIMBATORE-641035 3. A MATHIVANI A MATHIVANI, SNS COLLEGE OF TECHNOLOGY, SNS KALVI NAGAR, SATHY MAIN ROAD, VAZHIYAMPALAYAM PIRIVU, COIMBATORE-641035 4. K SENTHILKUMAR K SENTHILKUMAR, SNS COLLEGE OF TECHNOLOGY, SNS KALVI NAGAR, SATHY MAIN ROAD, VAZHIYAMPALAYAM PIRIVU, COIMBATORE-641035 , et al.		
<b>Date of Registration</b>	02/08/2022	
<b>Title</b>	SENSOR BASED SMART AGRICULTURE (SENSA)-ANALYZER	
<b>Priority NA</b>		

  

<b>Design Number</b>	378572-001	
<b>Class</b>	23-01	
<b>THOMAS MAGNETE GMBH Innomotion Park 3, 57562 Herdorf, Germany</b>		
<b>Date of Registration</b>	03/02/2023	
<b>Title</b>	HYDRAULIC VALVES	
<b>Priority</b>		
Priority Number	Date	Country
009155005-0001	23/08/2022	EUIPO

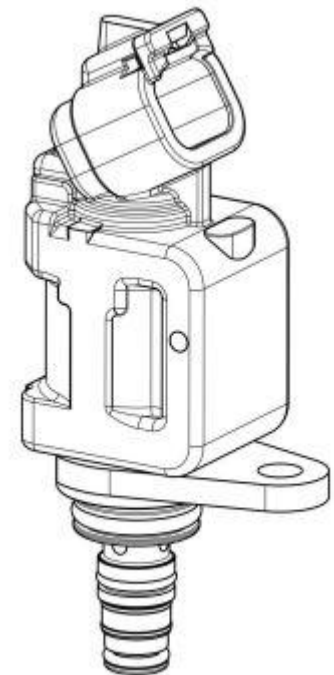
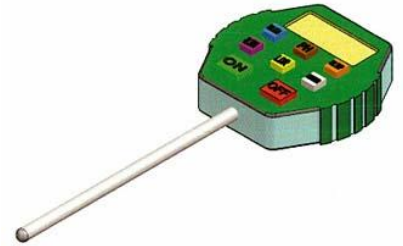

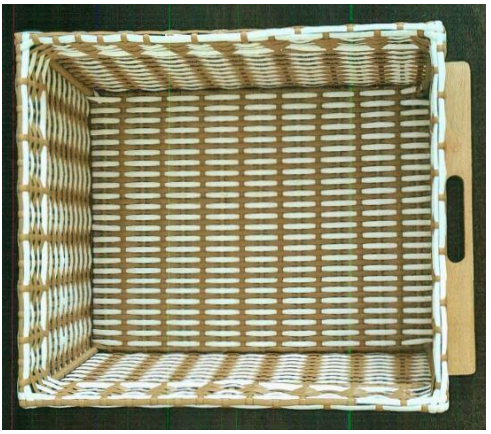



Design Number	377115-001	
Class	09-04	
Mr. Naren Naresh Betwala Grd Floor, Plot No. 534, A4 White House, Sona Wala Agairy Lane, Near Canossa High School, Mahim-West, Mumbai, Maharashtra - 400016, India		
Date of Registration	10/01/2023	
Title	PVC WICKER BASKET.	
Priority NA		

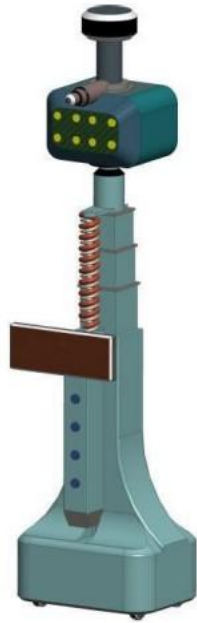

Design Number	378768-001	
Class	08-03	
1.Dev Bhoomi Uttarakhand University Dev Bhoomi Uttarakhand University, Chakrata Road Navgaon, Manduwala, Dehradun, Uttarakhand 248007, India. 2. Surender Singh Bisht Head of Department, School of Hotel Management & Tourism, Dev Bhoomi Uttarakhand University, Chakrata Road Navgaon, Manduwala, Dehradun, Uttarakhand 248007, India. 3. Dr. Mahesh Uniyal Dean, School of Hotel Management & Tourism, Dev Bhoomi Uttarakhand University, Chakrata Road Navgaon, Manduwala, Dehradun, Uttarakhand-248007, India. 4. Chandramauli Dhondhiyal Dean, School of Hotel Management & Tourism, Dev Bhoomi Uttarakhand University, Chakrata Road Navgaon, Manduwala, Dehradun, Uttarakhand 248007, India. , et al.		
Date of Registration	06/02/2023	
Title	KITCHEN KNIFE	
Priority NA		

Design Number	378545-001	
Class	24-02	
1.Sai Nitisha Tadiboina Master Software Engineer, Computer Science, Geico and 5260 Western Avenue, Chevy Chase MD 20815 USA 2. Ganesh Babasaheb Akat Assistant Professor, UG & PG Department of Chemistry, Kohinoor Arts, Commerce & Science College, Sulibhanjan Khultabad, Dist. Aurangabad, (MS) India 3. Dr. Lakshminarayana SA Professor and Head, Department of microbiology, Rajarajeswari Medical College and Hospital, Bangalore, Karnataka, India 4. Dr. Dhondiram Tukaram Sakhare Assistant Professor, Department of Chemistry, Shivaji Art's, Comm. & Science College Kannad Dist. Aurangabad Maharashtra, India, 431103 , et al.		
Date of Registration	03/02/2023	
Title	DEVICE DISCHARGING FERRITE NANOPARTICLE MEDICATION	
Priority NA		

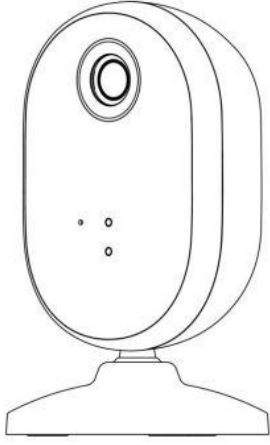

<b>Design Number</b>	379330-001	
<b>Class</b>	10-05	
<b>Title</b>	CRACK DETECTION DEVICE IN STRUCTURE	
<p>1.YSPM's Yashoda Technical Campus YSPM'S, Yashoda Technical Campus, Satara-415011, Maharashtra, India 2. Mr. Salman Asif Jamadar A/P: Kavathe, Taluka: Wai, District: Satara. Pin code: 415516 3. Mr. Akshay Mahadew Pawar Matkar colony shahupuri, Satara. Pin code: 415002 4. Mr. Ajit Jagannath Dounde A/P: Jakatwadi, Taluka/District: Satara Pin code: 415001 , et al.</p>		
<b>Date of Registration</b>	15/02/2023	
<b>Priority NA</b>		
		
<b>Design Number</b>	379332-001	
<b>Class</b>	12-05	
<b>Title</b>	TROLLEY WITH LOAD-MEASURING SENSORS	
<p>1.Sant Gajanan Maharaj College Of Engineering, Mahagaon Site- Chinchewadi, Gadhigraj Hasurwadi Road, Chincewadi, Mahagaon, Gadhingraj, Maharashtra 416503 2. Miss. Sakshi Nandkumar Kupekar Final Year B. Tech E&amp;TC Student, Sant Gajanan Maharaj College of Engineering, Mahagaon, Maharashtra 416503 3. Miss. Susmita Pralhad More Final Year B. Tech E&amp;TC Student, Sant Gajanan Maharaj College of Engineering, Mahagaon, Maharashtra 416503 4. Miss. Divya Deepakrao Desai Final Year B. Tech E&amp;TC Student, Sant Gajanan Maharaj College of Engineering, Mahagaon, Maharashtra 416503 , et al.</p>		
<b>Date of Registration</b>	15/02/2023	
<b>Priority NA</b>		
		
<b>Design Number</b>	378279-001	
<b>Class</b>	21-01	
<b>Title</b>	STUFFED TOY DOLL	
<p>1.Avani Modi Sarkar 151 Henley Place, Apt.210, Weehawken, NJ 07086, USA. 2. Charu Modi 21 Marco Polo Court, Franklin Park, NJ 08823, USA. 3. Viral Modi 21 Marco Polo Court, Franklin Park, NJ 08823, USA.</p>		
<b>Date of Registration</b>	30/01/2023	
<b>Priority</b>		
<b>Priority Number</b>	<b>Date</b>	<b>Country</b>
29/863,094	15/12/2022	U.S.A.
		

<b>Design Number</b>	379266-001		
<b>Class</b>	16-01		
<b>SIGNIFY HOLDING B.V. Eindhoven of High Tech Campus 48, 5656 AE Eindhoven, The Netherlands.</b>			
<b>Date of Registration</b>	14/02/2023		
<b>Title</b>	CAMERA		
<b>Priority</b>			
Priority Number	Date	Country	
009156581-0001	24/08/2022	EUIPO	
<b>Design Number</b>	378659-001		
<b>Class</b>	23-01		
<b>KOHLER CO. 444 HIGHLAND DRIVE, KOHLER, WISCONSIN, USA-53044</b>			
<b>Date of Registration</b>	04/02/2023		
<b>Title</b>	FAUCET HANDLE		
<b>Priority NA</b>			
<b>Design Number</b>	377484-001		
<b>Class</b>	23-08		
<b>Kishan Steel Tech Virani Aghat, 5-Ghanshyam Industrial Area, Dhebar Road, Nr. Rajkamal Crossing, Rajkot-360 002, Gujarat - (India), Proprietor is Chandubhai Naranbhai Davra</b>			
<b>Date of Registration</b>	16/01/2023		
<b>Title</b>	SOAP DISH		
<b>Priority NA</b>			

<b>Design Number</b>	375326-001		
<b>Class</b>	02-02		
<b>SABYASACHI CALCUTTA LLP 80/2 Topsia Road (South), Kolkata-700046, West Bengal.</b>			
<b>Date of Registration</b>	09/12/2022		
<b>Title</b>	GARMENT		
<b>Priority NA</b>			
<b>Design Number</b>	374186-001		
<b>Class</b>	24-02		
<b>Colgate-Palmolive Company 300 Park Avenue, New York 10022, USA</b>			
<b>Date of Registration</b>	15/11/2022		
<b>Title</b>	Applicator Tip for Oral Cavity Treatment		
<b>Priority</b>			
<b>Priority Number</b>	<b>Date</b>	<b>Country</b>	
29/839,278	19/05/2022	U.S.A.	
<b>Design Number</b>	363587-001		
<b>Class</b>	21-01		
<b>KTI India Private Limited 91 Spring Board Business Hub Pvt Ltd, 74/II, 'C' Cross Road, Opp. Gate No.2, Seepz, MIDC, Andheri (E), Mumbai – 400093, Maharashtra, India.</b>			
<b>Date of Registration</b>	03/05/2022		
<b>Title</b>	Spin Game		
<b>Priority NA</b>			

<b>Design Number</b>	354814-001	
<b>Class</b>	28-03	
<b>THE GILLETTE COMPANY LLC One Gillette Park, Boston, Massachusetts 02127, United States of America</b>		
<b>Date of Registration</b>	13/12/2021	
<b>Title</b>	SHAVING RAZOR CARTRIDGE DISPENSER	
<b>Priority</b>		
Priority Number	Date	Country
29/795562	18/06/2021	U.S.A.





<b>Design Number</b>	379252-001
<b>Class</b>	11-01
<b>M/s. TANAY GEMS &amp; JEWELS FLAT NO. 3589, 4TH CROSSING, MSB KA RASTA, BOHRAJI KA DARWAJA, NEAR VEER SAWARKAR SCHOOL, JOHARI BAZAR, JAIPUR-302003, RAJASTHAN</b>	
<b>Date of Registration</b>	14/02/2023
<b>Title</b>	JEWELLERY
<b>Priority NA</b>	



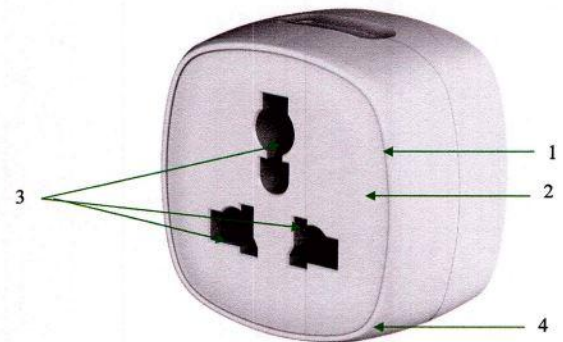

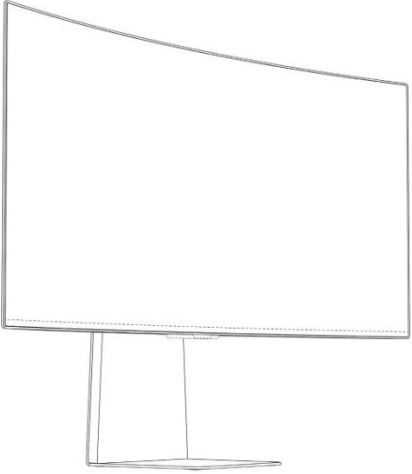
<b>Design Number</b>	379492-001
<b>Class</b>	13-03
<b>V-Guard Industries Ltd 42/962, Vennala High School Road, Vennala, Kochi – 682028, Kerala State</b>	
<b>Date of Registration</b>	16/02/2023
<b>Title</b>	Smart plug
<b>Priority NA</b>	

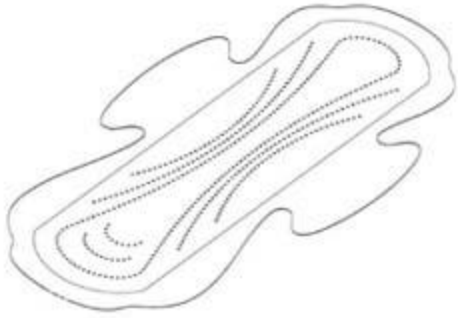



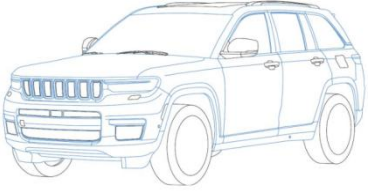

<b>Design Number</b>	366423-001		
<b>Class</b>	14-02		
<b>SAMSUNG ELECTRONICS CO., LTD. 129, Samsung-ro, Yeongtong-gu, Suwon-si, Gyeonggi-do, Republic of Korea</b>			
<b>Date of Registration</b>	20/06/2022		
<b>Title</b>	MONITOR		
<b>Priority</b>			
Priority Number	Date	Country	
30-2021-0061774	22/12/2021	Republic of Korea	
<b>Design Number</b>	323656-001		
<b>Class</b>	23-01		
<b>Evolution Aqua Limited Kellet Close, Wigan, WN5 0LP, United Kingdom</b>			
<b>Date of Registration</b>	14/11/2019		
<b>Title</b>	Water Filter		
<b>Priority</b>			
Priority Number	Date	Country	
006471132-0001	16/05/2019	EUIPO	
<b>Design Number</b>	346662-001		
<b>Class</b>	24-04		
<b>SPARKLE ECO INNOVATIONS PRIVATE LIMITED SY No. 93/2, P No. 7 to 10, 1st Floor, Virani Building, Diamond Estate, Near Mohanbaug, Varachha Road, Surat 395006 Gujarat, India</b>			
<b>Date of Registration</b>	21/07/2021		
<b>Title</b>	SANITARY PAD		
<b>Priority NA</b>			

<b>Design Number</b>	349822-001	
<b>Class</b>	25-01	
<b>Siri Maharaja Granites Private Limited E-315A, Road No. 16, VKIA, Sikar Road - Jaipur - 302013, Rajasthan, India</b>		
<b>Date of Registration</b>	20/09/2021	
<b>Title</b>	Tiles	
<b>Priority NA</b>		
<b>Design Number</b>	334398-001	
<b>Class</b>	06-06	
<b>NANA SHENDKAR PRABHA KUTIR, GANESH GALLI. LALBAUGH, MUMBAI-400012</b>		
<b>Date of Registration</b>	18/10/2020	
<b>Title</b>	TABLE SHIELD	
<b>Priority NA</b>		
<b>Design Number</b>	376303-001	
<b>Class</b>	23-01	
<b>MR SAMEER DHIRUBHAI CHOTHANI RAMESHWAR RESIDENCY, STREET NO 04, BLOCK NO 66, ROLEX ROAD, KOTHARIYA, RAJKOT-360022, INDIA</b>		
<b>Date of Registration</b>	28/12/2022	
<b>Title</b>	NON-RETURN VALVE	
<b>Priority NA</b>		

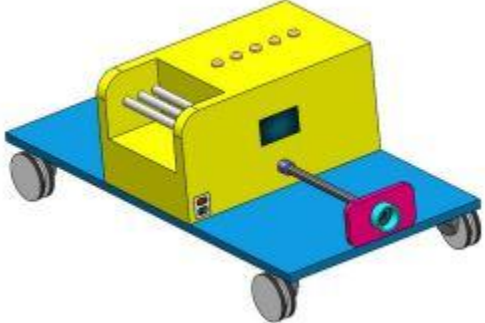
<b>Design Number</b>	345615-001		
<b>Class</b>	12-08		
<b>FCA US LLC 1000 Chrysler Drive, Auburn Hills, Michigan 48326, United States of America</b>			
<b>Date of Registration</b>	02/07/2021		
<b>Title</b>	"AUTOMOBILE BODY"		
<b>Priority</b>			
Priority Number	Date	Country	
29/764,835	04/01/2021	U.S.A.	



<b>Design Number</b>	376430-001		
<b>Class</b>	21-01		
<b>1. KONGU ENGINEERING COLLEGE PERUNDURAI, ERODE-638060, TAMILNADU 2. DR G.S RAMPRADHEEP DEPARTMENT OF CIVIL ENGINEERING, KONGU ENGINEERING COLLEGE, PERUNDURAI, ERODE-638060, TAMILNADU 3. DR S KOTHAI PALANISAMY DEPARTMENT OF CIVIL ENGINEERING, KONGU ENGINEERING COLLEGE, PERUNDURAI, ERODE-638060, TAMILNADU 4. DR AMBIKA DEVARAJAN DEPARTMENT OF CIVIL ENGINEERING, KONGU ENGINEERING COLLEGE, PERUNDURAI, ERODE-638060, TAMILNADU , et al.</b>			
<b>Date of Registration</b>	30/12/2022		
<b>Title</b>	EDUCATIONAL TOY FOR GOOD TOUCH AND BAD TOUCH		
<b>Priority NA</b>			

<b>Design Number</b>	378612-001		
<b>Class</b>	10-05		
<b>1. Dr. Saikat Maity Professor, Department of Computer Science and Engineering, Sister Nivedita University, DG 1/2 New Town, Action Area 1, Kolkata – 700156, West Bengal, India. 2. Dr. Souvik Pal Associate Professor, Department of Computer Science and Engineering, Sister Nivedita University, DG 1/2 New Town, Action Area 1, Kolkata – 700156, West Bengal, India. 3. Dr. Sanjay Chakraborty Associate Professor, Department of Computer Science and Engineering, Techno International New Town, 1/1, Service Rd, DG Block(Newtown), Action Area I, Newtown, Chakpachuria, West Bengal 700156, India. 4. Dr. Lopamudra Dey Assistant Professor, Department of Computer Science and Engineering , Heritage Institute of Technology, Chowbaga Rd, Anandapur, Mundapara, Kolkata, West Bengal 700107, India , et al.</b>			
<b>Date of Registration</b>	03/02/2023		
<b>Title</b>	IOT BASED AUTOMATED RAIL TRACK INSPECTION TROLLEY		
<b>Priority NA</b>			

<b>Design Number</b>	378457-001	
<b>Class</b>	14-02	
<b>1. Dr. Imran Khan Assistant Professor, Department of Computer Science and Engineering, Harcourt Butler Technical University, Kanpur, Uttar Pradesh, India 2. Dr. Sunil Kumar Assistant Professor, Department of Computer Science, Guru Nanak College, Sri Muktsar Sahib, Punjab, India 3. Dr. Padmavati Shrivastava Associate Professor, Department of Computer Science and Engineering, BIT , Raipur, India 4. Dr. Punit Kumar Dwivedi Professor &amp; Group Director, Modern Institute of Professional Studies, Modern Group of Institutions, Indore, Madhya Pradesh, India , et al.</b>		
<b>Date of Registration</b>	02/02/2023	
<b>Title</b>	“ARTIFICIAL INTELLIGENCE BASED USB DEVICE FOR MANAGING MULTIPLE SMART DEVICES”.	
<b>Priority NA</b>		
<b>Design Number</b>	378313-001	
<b>Class</b>	24-01	
<b>1. Dr. Megha Mishra Associate Professor Computer science &amp; Engineering Shri Shankarcharya Technical Campus, Bhilai 2. Dr. Vishnu Kumar Mishra Assistant professor Computer Science &amp; Engineering, Malla Reddy College of Engg. Hyderabad. 3. Dr. B L RAJU Professor &amp; Principal, ACE ENGINEERING COLLEGE, Ankushapur, Ghatkesar Hyderabad – 501301 Telangana-India 4. Dr. Rajesh H. Kulkarni Associate Professor CSE Dept. MVSR Engineering College Hyderabad- 501510 Telangana-India , et al.</b>		
<b>Date of Registration</b>	31/01/2023	
<b>Title</b>	WEARABLE HEALTH MONITORING JACKET	
<b>Priority NA</b>		
<b>Design Number</b>	380022-001	
<b>Class</b>	11-01	
<b>SABYASACHI CALCUTTA LLP 80/2 Topsia Road (South), Kolkata-700046, West Bengal.</b>		
<b>Date of Registration</b>	24/02/2023	
<b>Title</b>	JEWELLERY	
<b>Priority NA</b>		

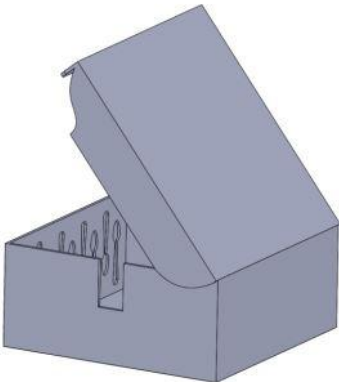

<b>Design Number</b>	378895-004		
<b>Class</b>	13-03		
<b>HASUBHAI CHHAGANBHAI VALIYA Ground Floor, 84, Opp Bhikshuk Gruh, Road Number 1 Odhav, Ahmedabad, Gujarat,382415</b>			
<b>Date of Registration</b>	08/02/2023		
<b>Title</b>	Industrial Plug & Sockets		
<b>Priority NA</b>			
<b>Design Number</b>	379490-001		
<b>Class</b>	12-11		
<b>ENDURANCE TECHNOLOGIES LIMITED E-92, M.I.D.C. Industrial Area, Waluj, Aurangabad – 431136, Maharashtra, India</b>			
<b>Date of Registration</b>	16/02/2023		
<b>Title</b>	Outer Tube for Suspension of Two-Wheeler		
<b>Priority NA</b>			
<b>Design Number</b>	345943-001		
<b>Class</b>	14-02		
<b>HUAWEI TECHNOLOGIES CO., LTD. Huawei Administration Building, Bantian, Longgang District, Shenzhen, Guangdong 518129, P. R. China</b>			
<b>Date of Registration</b>	08/07/2021		
<b>Title</b>	MOUSE		
<b>Priority</b>			
<b>Priority Number</b>	<b>Date</b>	<b>Country</b>	
202130109612.5	26/02/2021	China	

<b>Design Number</b>	364670-001	
<b>Class</b>	09-03	
<b>1. JECRC University Plot No. IS-2036 to IS-2039 Ramchandrapura Industrial Area Jaipur, Sitapura, Vidhani, Rajasthan-303905, India. 2. Shivani Kaushik Dean, Department of Design, JECRC University, Plot No. IS- 2036 to IS-2039 Ramchandrapura Industrial Area Jaipur, Sitapura, Vidhani, Rajasthan-303905, India. 3. Ravina Parihar Department of Law, JECRC University, Plot No. IS-2036 to IS-2039 Ramchandrapura Industrial Area Jaipur, Sitapura, Vidhani, Rajasthan-303905, India. 4. Dr. Namita Jain Department of Law, JECRC University, Plot No. IS- 2036 to IS-2039 Ramchandrapura Industrial Area Jaipur, Sitapura, Vidhani, Rajasthan-303905, India. , et al.</b>		
<b>Date of Registration</b>	24/05/2022	
<b>Title</b>	CAKE BOX	
<b>Priority NA</b>		
<b>Design Number</b>	375680-001	
<b>Class</b>	22-06	
<b>1. Ranjith Balasubramaniam Bungalow No. 366, Road No. 3, Sindh Society, Aundh Pune-411007, MS India 2. Shakil Abdul Aziz Shaikh Flat. No 502, Riya Residency, 33/34 Nanak Society, Behind Salunke vihar Telephone Exchange, Pune-411048, MS, India</b>		
<b>Date of Registration</b>	15/12/2022	
<b>Title</b>	MOSQUITO REPELLENT MACHINE	
<b>Priority NA</b>		
<b>Design Number</b>	378699-001	
<b>Class</b>	06-06	
<b>NILKAMAL LIMITED NILKAMAL HOUSE, PLOT NO. 77/78, STREET NO.14, M.I.D.C., ANDHERI (EAST), MUMBAI 400093, MAHARASHTRA, INDIA</b>		
<b>Date of Registration</b>	06/02/2023	
<b>Title</b>	BACK REST FOR CHAIR	
<b>Priority NA</b>		

<b>Design Number</b>	352553-001	
<b>Class</b>	09-03	
<b>THE PROCTER &amp; GAMBLE COMPANY One Procter &amp; Gamble Plaza, Cincinnati, OH 45202, United States of America</b>		
<b>Date of Registration</b>	02/11/2021	
<b>Title</b>	MEDICINAL CONTAINER	
<b>Priority</b>		
Priority Number	Date	Country
29/782349	06/05/2021	U.S.A.



<b>Design Number</b>	379356-001	
<b>Class</b>	14-03	
<b>UNIGLOBE INFOTECH PRIVATE LIMITED C-147, S/F, OKHLA PHASE-1, NEW DELHI-110020</b>		
<b>Date of Registration</b>	15/02/2023	
<b>Title</b>	WIFI ROUTER	
<b>Priority NA</b>		

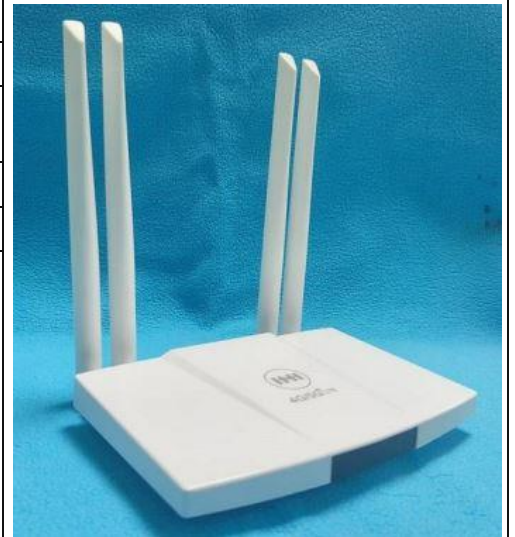

<b>Design Number</b>	352272-001	
<b>Class</b>	12-15	
<b>Apollo Tyres Global R&amp;D B.V. Colosseum 2, 7521 PT, Enschede, Netherlands</b>		
<b>Date of Registration</b>	29/10/2021	
<b>Title</b>	TIRE TREAD	
<b>Priority</b>		
Priority Number	Date	Country
29/781,572	30/04/2021	U.S.A.



<b>Design Number</b>	379014-001	
<b>Class</b>	03-01	
<b>SAMSUNG ELECTRONICS CO., LTD. 129, Samsung-ro, Yeongtong-gu, Suwon-si, Gyeonggi-do, Republic of Korea</b>		
<b>Date of Registration</b>	09/02/2023	
<b>Title</b>	CASE FOR MOBILE PHONE	
<b>Priority</b>		
Priority Number	Date	Country
30-2022-0032781	12/08/2022	Republic of Korea

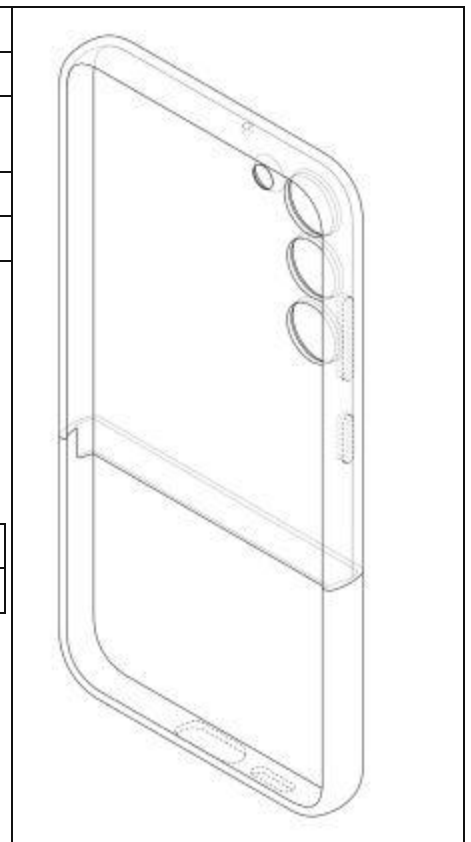





<b>Design Number</b>	377818-001	
<b>Class</b>	15-03	
<b>Dhiman Industries Khanna to Amlah Road, Majri Kishne Wali, Amlah, District-Fatehgarh Sahib-147203, India, Proprietor is Sharanjit Kaur</b>		
<b>Date of Registration</b>	23/01/2023	
<b>Title</b>	AGRICULTURAL MACHINE	
<b>Priority NA</b>		



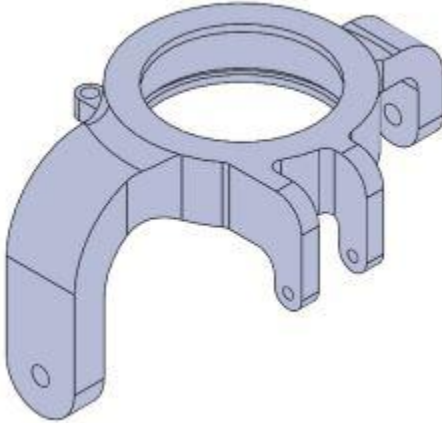
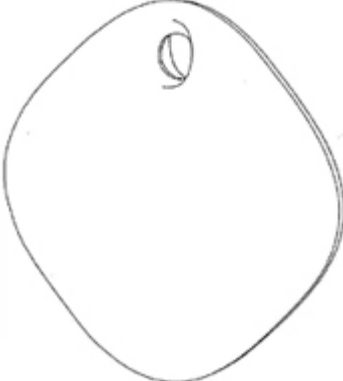

<b>Design Number</b>	347521-001	
<b>Class</b>	11-02	
<b>ASHISH KANSAL 173, Rajdhani Enclave, Pitampura, New Delhi 110034 India</b>		
<b>Date of Registration</b>	07/08/2021	
<b>Title</b>	Flower Pot	
<b>Priority NA</b>		

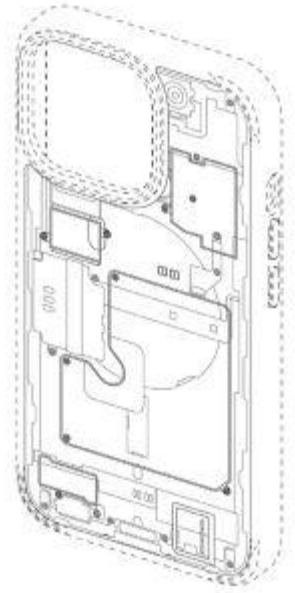

<b>Design Number</b>	378832-001		
<b>Class</b>	12-16		
<b>1. Shri VILE PARLE KELAVANI MANDAL'S DWARKADAS J. SANGHVI COLLEGE OF ENGINEERING U-15, JVPD Scheme, Bhaktivedanta Swami Road, Opp. Cooper Hospital, Vile Parle West, Mumbai – 400056</b> <b>2. HARI VASUDEVAN SVKM'S Dwarkadas J. Sanghvi College of Engineering U-15, JVPD Scheme, Bhaktivedanta Swami Road, Opp. Cooper Hospital, Vile Parle West, Mumbai - 400056</b> <b>3. K.N VIJAYA KUMAR SVKM'S Dwarkadas J. Sanghvi College of Engineering U-15, JVPD Scheme, Bhaktivedanta Swami Road, Opp. Cooper Hospital, Vile Parle West, Mumbai – 400056</b> <b>4. RAJNARAYAN YADAV B-1501, Parinee Essence, Bhabhrekar nagar, Opp JMD Skoda Workshop, Kandivali (west), Maharashtra, India- 400067 , et al.</b>			
<b>Date of Registration</b>	07/02/2023		
<b>Title</b>	STEERING WHEEL JOINT		
<b>Priority NA</b>			
<b>Design Number</b>	339032-001		
<b>Class</b>	14-03		
<b>SAMSUNG ELECTRONICS CO., LTD. 129, Samsung-ro, Yeongtong-gu, Suwon-si, Gyeonggi-do, 16677, Republic of Korea</b>			
<b>Date of Registration</b>	12/02/2021		
<b>Title</b>	ELECTRONIC TAG		
<b>Priority</b>			
<b>Priority Number</b>	<b>Date</b>	<b>Country</b>	
30-2020-0056221	19/11/2020	Republic of Korea	
<b>Design Number</b>	377631-002		
<b>Class</b>	06-04		
<b>Cept University Kasturbhai Lalbhai Campus, University Road, Navarangpura, Ahmedabad - 380009, Gujarat State, India</b>			
<b>Date of Registration</b>	18/01/2023		
<b>Title</b>	WOODEN SHELVING SYSTEM		
<b>Priority NA</b>			

<b>Design Number</b>	378977-001		
<b>Class</b>	03-01		
<b>Spigen Korea Co., Ltd. 446, Bongeunsa-ro, Gangnam-gu, Seoul 06153, Republic of Korea</b>			
<b>Date of Registration</b>	09/02/2023		
<b>Title</b>	Case for Electronic Communications Device		
<b>Priority</b>			
Priority Number	Date	Country	
29/866,554	19/09/2022	U.S.A.	
<b>Design Number</b>	337262-001		
<b>Class</b>	04-02		
<b>vVARDIS AG SIHLBRUGGSTRASSE 109, 6340 BAAR, SWITZERLAND</b>			
<b>Date of Registration</b>	06/01/2021		
<b>Title</b>	TOOTHBRUSH		
<b>Priority</b>			
Priority Number	Date	Country	
WIPO98746	20/10/2020	Switzerland	
<b>Design Number</b>	376736-001		
<b>Class</b>	23-04		
<b>Smt . Rina Jaiswal Plot No - 8, Phase - 1, Sancharpuri Colony, Old Airport Road, Bowenpally, Tirumalagiri, Hyderabad, Bowenpally, Andhra Pradesh - 500011, India</b>			
<b>Date of Registration</b>	05/01/2023		
<b>Title</b>	CEILING FAN BLADE		
<b>Priority NA</b>			

<b>Design Number</b>	379503-001	
<b>Class</b>	31-00	
<b>V-Guard Industries Ltd 42/962, Vennala High School Road, Vennala, Kochi – 682028, Kerala State</b>		
<b>Date of Registration</b>	16/02/2023	
<b>Title</b>	Juicer Jar	
<b>Priority NA</b>		

<b>Design Number</b>	337425-001	
<b>Class</b>	06-04	
<b>1. BHANU PRATAP SAINI H.No. 1/77, Mathura Refinery Nagar Township, Mathura, PIN: 281006 2. GURDEEP SINGH New Married Scholar Quarter No. 307, IIT Guwahati Campus 3. ARSHDEEP KAUR New Married Scholar Quarter No. 307, IIT Guwahati Campus 4. Dr. GURUMUKH DAS 4/135 Vidyut Nagar, Dayalbagh, Agra</b>		
<b>Date of Registration</b>	11/01/2021	
<b>Title</b>	ERGONOMIC KITCHEN ACCESSORIES CABINET	
<b>Priority NA</b>		

<b>Design Number</b>	378754-001	
<b>Class</b>	15-99	
<b>THALETEC GmbH Steinbachstraße 3, 06502 Thale, Germany</b>		
<b>Date of Registration</b>	06/02/2023	
<b>Title</b>	Mixers, industrial	
<b>Priority</b>		
<b>Priority Number</b>	<b>Date</b>	<b>Country</b>
WIPO121159	08/08/2022	WIPO

<b>Design Number</b>	338554-001	
<b>Class</b>	13-03	
<b>DANFOSS POWER ELECTRONICS A/S Ulsnæs 1 DK-6300 Gråsten Denmark</b>		
<b>Date of Registration</b>	03/02/2021	
<b>Title</b>	FREQUENCY CONVERTER	
<b>Priority</b>		
Priority Number	Date	Country
008074363-0007	04/08/2020	EUIPO





<b>Design Number</b>	378861-001
<b>Class</b>	24-01
<b>1. Priya Saxena Assistant Professor, Mahatma Gandhi college of pharmacy, Lucknow 2. Preeti Sharma Assistant Professor, Pranveer Singh Institute of technology, Pharmacy Kanpur UP 3. km Arjoo khatoon Assistant Professor, Rajiv gandhi college of pharmacy, nautanwa Maharajganj, UP 4. Khushboo Gaur Assistant Professor, Pranveer Singh Institute of technology, Pharmacy Kanpur UP , et al.</b>	
<b>Date of Registration</b>	07/02/2023
<b>Title</b>	IOT BASED MEDICAL MONITORING DEVICE
<b>Priority NA</b>	







<b>Design Number</b>	360004-001
<b>Class</b>	12-11
<b>1. Dr. Syed Khader Basha Assistant Professor, MED Muffakham Jah college of Engineering &amp; Technology, 8-2-249 to 267, Mount Pleasant, Road Number 3, Banjara Hills, Hyderabad, Telangana 500034 2. Dr. Ishrat Meera Mirzana Professor, MED, MJCET, Hyd, TS-34 3. Syeda Romana Assistant Professor, MED, MJCET, Hyd, TS-34 4. Shaik Irfan Sadaq Assistant Professor, MED, MJCET, Hyd, TS-34 , et al.</b>	
<b>Date of Registration</b>	06/03/2022
<b>Title</b>	ELECTRIC BIKE
<b>Priority NA</b>	



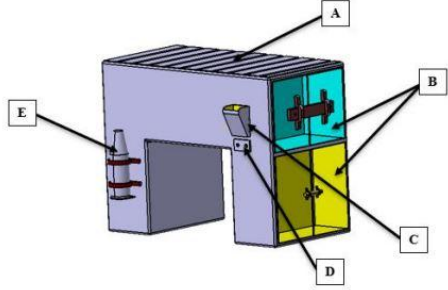
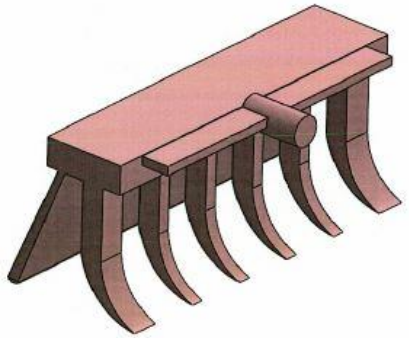
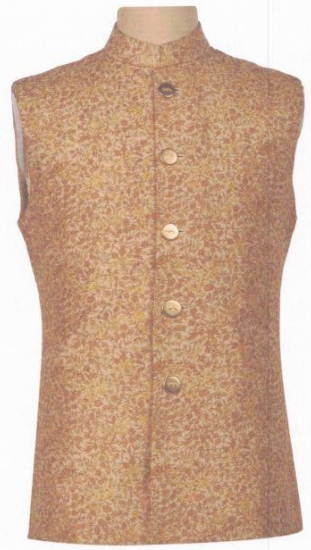

<b>Design Number</b>	376541-001	
<b>Class</b>	24-01	
<b>1. Sri Manakula Vinayagar Engineering College, Madagadipet, Puducherry - 605 107, India 2. Dr. V. S. K. Venkatachalapathy, Director Cum Principal, Sri Manakula Vinayagar Engineering College, Madagadipet, Puducherry - 605 107, India 3. Dr. N. Deepa, Assistant Professor, Department of Biomedical Engineering, Sri Manakula Vinayagar Engineering College, Madagadipet, Puducherry - 605 107, India 4. M. Hemachandran, Department of Biomedical Engineering, Sri Manakula Vinayagar Engineering College, Madagadipet, Puducherry - 605 107, India , et al.</b>		
<b>Date of Registration</b>	02/01/2023	
<b>Title</b>	LED PHOTOTHERAPY DEVICE	
<b>Priority NA</b>		
<b>Design Number</b>	377471-001	
<b>Class</b>	06-11	
<b>Amit Gupta Mohini Creations, Plot No. 4, Ganesh Vihar, Keshopura, Bhankrota, Jaipur, Rajasthan-302026, India</b>		
<b>Date of Registration</b>	16/01/2023	
<b>Title</b>	TWO SIDE SCALLOPED FLAT WEAVE RUG	
<b>Priority NA</b>		
<b>Design Number</b>	376619-003	
<b>Class</b>	11-02	
<b>Michael Aram India Private Limited A-41, Sector - 80, Phase - II, Noida - 201305, U.P., India</b>		
<b>Date of Registration</b>	03/01/2023	
<b>Title</b>	VASE.	
<b>Priority NA</b>		

<b>Design Number</b>	365277-001	
<b>Class</b>	09-03	
<b>1.Mr. Girish Chandrakant Mekalke ChandraGiri Building, Plot No. 374, Near Jain Temple, Shahunagar, Jaysingpur-416101. Tal- Shirol, Dist:- Kolhapur, State:- Maharashtra 2. Mr. Rakesh Ramchandra Kolhapure Shiv Sadan, Plot No.62/B, Indira Housing Society, Kabnur, Dist.- Kolhapur, State - Maharashtra 3. Mr. Suyog Bapuso Rayjadhav 9/71, Opposite to Kamakshi Residency, Shikshak Colony, Plot No. 11, Ichalkaranji, Dist. - Kolhapur, State - Maharashtra</b>		
<b>Date of Registration</b>	02/06/2022	
<b>Title</b>	MULTICOMPARTMENT SMART DELIVERY BOX FOR E-COMMERCE AND FOOD DELIVERY BUSINESS APPLICATIONS	
<b>Priority NA</b>		
<b>Design Number</b>	376228-003	
<b>Class</b>	15-03	
<b>1.SIMATS SCHOOL OF ENGINEERING SAVEETHA NAGAR, THANDALAM, CHENNAI-602105, TAMILNADU, INDIA 2. KOTPATI NAVEEN DEPARTMENT OF COMPUTER SCIENCE AND ENGINEERING, SIMATS SCHOOL OF ENGINEERING, SAVEETHA NAGAR, THANDALAM, CHENNAI-602105, TAMILNADU, INDIA 3. DR R HARIHARAN DEPARTMENT OF ELECTICAL AND ELECTRONICS ENGINEERING, SIMATS SCHOOL OF ENGINEERING, SAVEETHA NAGAR, THANDALAM, CHENNAI-602105, TAMILNADU, INDIA 4. DR RAMYA MOHAN DEPARTMENT OF COMPUTER SCIENCE AND ENGINEERING, SIMATS SCHOOL OF ENGINEERING, SAVEETHA NAGAR, THANDALAM, CHENNAI-602105, TAMILNADU, INDIA , et al.</b>		
<b>Date of Registration</b>	27/12/2022	
<b>Title</b>	SMART WEED REMOVAL CULTIVATOR	
<b>Priority NA</b>		
<b>Design Number</b>	379406-001	
<b>Class</b>	02-02	
<b>SABYASACHI CALCUTTA LLP 80/2 Topsia Road (South), Kolkata-700046, West Bengal.</b>		
<b>Date of Registration</b>	15/02/2023	
<b>Title</b>	GARMENT	
<b>Priority NA</b>		



<b>Design Number</b>	323033-001	
<b>Class</b>	12-09	
<b>Mahindra &amp; Mahindra Limited Mahindra Research Valley, Mahindra World City, Plot No.41/1, Anjur P.O., Chengalpattu, Kanchipuram District, Tamil Nadu - 603 004, India</b>		
<b>Date of Registration</b>	25/10/2019	
<b>Title</b>	Tractor Hood	
<b>Priority NA</b>		
<b>Design Number</b>	375198-020	
<b>Class</b>	11-01	
<b>Aulyra Design Private Limited 3rd floor, Plot No. 3807, Phase 4, Chakkarpur, Gurugram, Haryana - 122001</b>		
<b>Date of Registration</b>	07/12/2022	
<b>Title</b>	Earrings	
<b>Priority NA</b>		
<b>Design Number</b>	356457-001	
<b>Class</b>	07-99	
<b>Mahendra Jain Shop No. 133-A, Dadiseth Road, Opp. Malad Sahakari Bank, Malad (West), Mumbai - 400 064</b>		
<b>Date of Registration</b>	10/01/2022	
<b>Title</b>	Peacock Haldi Kumkum Holder	
<b>Priority NA</b>		

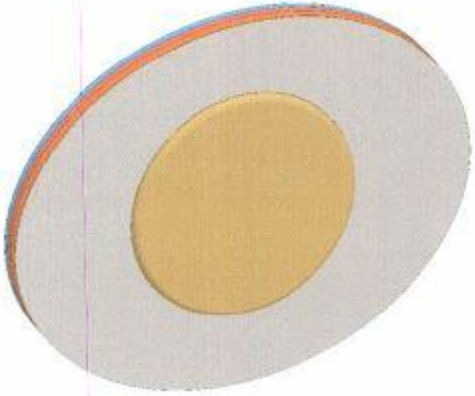

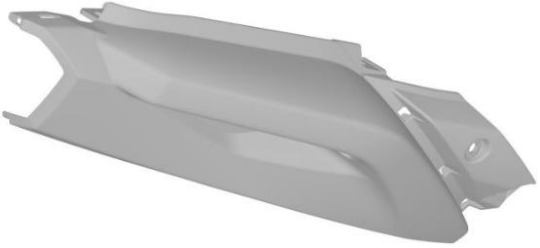
Design Number	344260-001	
Class	10-06	
<b>Vihan Electric Pvt Ltd Plot no 21, Opp Apple studio, Near Burmashell Petrol Pump, Village Valiv, Vasai (East) Dist: Palghar- 401208 Mumbai</b>		
Date of Registration	04/06/2021	
Title	Door Bell	
Priority NA		

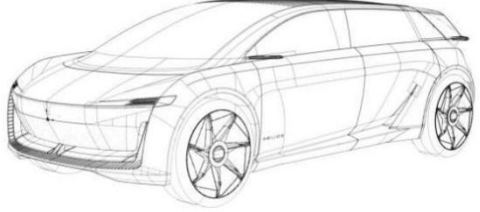
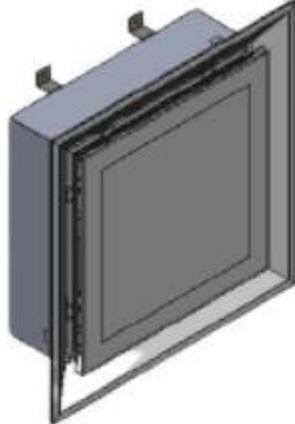
Design Number	376562-001	
Class	24-04	
<b>1. Pandit Deendayal Energy University Raisan Village, Gandhinagar-382007, Gujarat, India 2. Dr. S. Sundar Manoharan Director General, Pandit Deendayal Energy University, Raisan Village, Gandhinagar-382007, Gujarat, India 3. Dr. D. Sivaraman Assistant Professor, Pandit Deendayal Energy University, Raisan Village, Gandhinagar-382007, Gujarat, India 4. Dr. P. S. Pradeep Assistant Professor., MECH, Pandit Deendayal Energy University, Raisan Village, Gandhinagar-382007, Gujarat, India , et al.</b>		
Date of Registration	02/01/2023	
Title	HYBRID SECONDARY WOUND DRESSING PAD	
Priority NA		

Design Number	322915-001	
Class	12-11	
<b>Hero MotoCorp Limited 34, Community Center, Basant Lok, Vasant Vihar, New Delhi - 110057</b>		
Date of Registration	23/10/2019	
Title	BODY COVER FOR VEHICLE	
Priority NA		

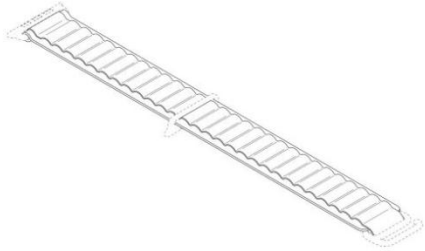

<b>Design Number</b>	356958-001	
<b>Class</b>	06-03	
<b>Bluewud Concepts Pvt. Ltd A 108, A Block, Sector 65, Noida, Uttar Pradesh 201301 - Bluewud Concepts Pvt. Ltd.</b>		
<b>Date of Registration</b>	19/01/2022	
<b>Title</b>	Centre Table	
<b>Priority NA</b>		
<b>Design Number</b>	363667-001	
<b>Class</b>	12-08	
<b>TATA PASSENGER ELECTRIC MOBILITY LIMITED Nanavati Mahalaya, Flr 3 &amp; 4, Plot 18, Mudhana Shetty Marg, Nr BSE, Fort, Mumbai, Mumbai City, Maharashtra, India, 400001.</b>		
<b>Date of Registration</b>	04/05/2022	
<b>Title</b>	VEHICLE	
<b>Priority NA</b>		
<b>Design Number</b>	378692-001	
<b>Class</b>	23-04	
<b>MRS. SWATI BHUSHAN MARDE MR. BHUSHAN RAMCHANDRA MARDE A 2101 / 2201 , Matoshri Pearl, S Keer Road, Mahim (W), Mumbai - 4000 16, Maharashtra, India</b>		
<b>Date of Registration</b>	06/02/2023	
<b>Title</b>	Dynamic Diffuser for VAV Air Distribution	
<b>Priority NA</b>		

<b>Design Number</b>	341630-001		
<b>Class</b>	19-06		
<b>1.M.Murugesan 3B/25, Kavetty Nagar 5th Street, Sowripalayam, Coimbatore 641 028 2. M.Kumaresan 3B/25, Kavetty Nagar 5th Street, Sowripalayam, Coimbatore 641 028 3. G.Akilandeswari 3B/25, Kavetty Nagar 5th Street, Sowripalayam, Coimbatore 641 028</b>			
<b>Date of Registration</b>	30/03/2021		
<b>Title</b>	DRAFTING APPARATUS		
<b>Priority NA</b>			
<b>Design Number</b>	378906-001		
<b>Class</b>	12-02		
<b>Ouseph P.D Peechanatt House, Gandhi Nagar II, Kothamangalam P.O, Pin code: 686691, Ernakulam District, Kerala S</b>			
<b>Date of Registration</b>	08/02/2023		
<b>Title</b>	Wheel Carrier		
<b>Priority NA</b>			
<b>Design Number</b>	339033-001		
<b>Class</b>	14-03		
<b>SAMSUNG ELECTRONICS CO., LTD. 129, Samsung-ro, Yeongtong-gu, Suwon-si, Gyeonggi-do, 16677, Republic of Korea</b>			
<b>Date of Registration</b>	12/02/2021		
<b>Title</b>	MOBILE PHONE		
<b>Priority</b>			
<b>Priority Number</b>	<b>Date</b>	<b>Country</b>	
30-2020-0060742	09/12/2020	Republic of Korea	

<b>Design Number</b>	375312-001		
<b>Class</b>	15-02		
<b>OPTUS HYDROTECH PRIVATE LIMITED PLOT NO 4, MAHAVIR INDUSTRIAL AREA, KOTDA SANGANI ROAD, OPP GETCO, VILLAGE-PIPLANA, TAL-KOTDA SANGANI, DIST-RAJKOT-360030, GUJARAT, INDIA</b>			
<b>Date of Registration</b>	09/12/2022		
<b>Title</b>	HYDRAULIC SUCKER ROAD PUMPING UNIT		
<b>Priority NA</b>			
<b>Design Number</b>	376532-001		
<b>Class</b>	15-99		
<b>1. Pandit Deendayal Energy University Raisan Village, Gandhinagar - 382007, Gujarat, India 2. Nirav Prajapati Research Scholar, Department of Chemical Engineering, Pandit Deendayal Energy University, Raisan Village, Gandhinagar - 382007, Gujarat, India 3. Surendra Singh Kachhwaha Professor, Department of Mechanical Engineering, Pandit Deendayal Energy University, Raisan Village, Gandhinagar - 382007, Gujarat, India 4. Dr. Pravin Kodgire Associate Professor, Department of Chemical Engineering, Pandit Deendayal Energy University, Raisan Village, Gandhinagar - 382007, Gujarat, India , et al.</b>			
<b>Date of Registration</b>	02/01/2023		
<b>Title</b>	BIODIESEL PRODUCTION PILOT PLANT		
<b>Priority NA</b>			
<b>Design Number</b>	380448-001		
<b>Class</b>	10-07		
<b>APPLE INC. One Apple Park Way, Cupertino, California 95014, United States of America</b>			
<b>Date of Registration</b>	28/02/2023		
<b>Title</b>	BAND FOR SMARTWATCH		
<b>Priority</b>			
<b>Priority Number</b>	<b>Date</b>	<b>Country</b>	
29/852,149	02/09/2022	U.S.A.	

<b>Design Number</b>	331824-001	
<b>Class</b>	06-01	
<b>Heema Dineshkumar Mistry 56, ONGC Nagar, C H Soc, Ajitnath C H Soc, Near New Panchayat Water Tank, Ranip, Ahmedabad - 382480, Gujarat, India</b>		
<b>Date of Registration</b>	10/08/2020	
<b>Title</b>	CHAIR	
<b>Priority NA</b>		
<b>Design Number</b>	379529-001	
<b>Class</b>	02-02	
<b>SABYASACHI CALCUTTA LLP 80/2 Topsia Road (South), Kolkata-700046, West Bengal.</b>		
<b>Date of Registration</b>	16/02/2023	
<b>Title</b>	SAREE AND BLOUSE (SET)	
<b>Priority NA</b>		
<b>Design Number</b>	355984-001	
<b>Class</b>	24-02	
<b>MEDAARA HEALTHCARE TECHNOLOGIES PRIVATE LIMITED 42/81 TTK Road, Alwarpet, Chennai - 600018, Tamil Nadu, India</b>		
<b>Date of Registration</b>	01/01/2022	
<b>Title</b>	Medical Device for Measuring Health Parameters	
<b>Priority NA</b>		

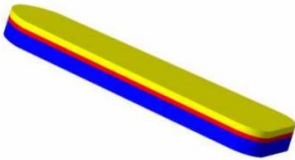

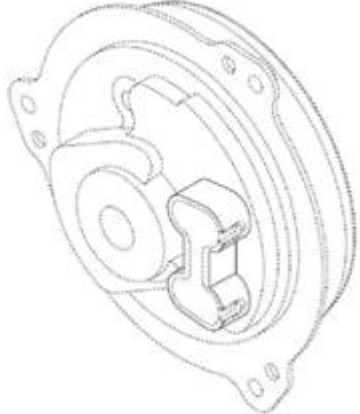

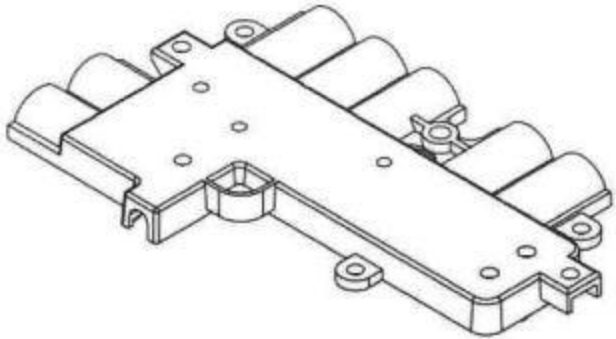
<b>Design Number</b>	379337-001		
<b>Class</b>	02-04		
<b>SREE CHITRA TIRUNAL INSTITUTE FOR MEDICAL SCIENCES &amp; TECHNOLOGY POOJAPPURA, TRIVANDRUM-695012, INDIA</b>			
<b>Date of Registration</b>	15/02/2023		
<b>Title</b>	MULTILAYER INSOLE SUBSYSTEM WITH CUSTOM REMOVABLE PEGS FOR PLANTAR PRESSURE OFFLOADING IN DIABETIC WALKERS		
<b>Priority NA</b>			
<b>Design Number</b>	339396-001		
<b>Class</b>	10-02		
<b>M/S. VIAN INTERNATIONAL KHASRA NO. 1122, RITHALA, DELHI-110085, INDIA.</b>			
<b>Date of Registration</b>	19/02/2021		
<b>Title</b>	WRIST WATCH		
<b>Priority NA</b>			
<b>Design Number</b>	340596-001		
<b>Class</b>	13-01		
<b>PANASONIC INTELLECTUAL PROPERTY MANAGEMENT CO., LTD. 1-61, Shiromi 2-chome, Chuo-ku, Osaka-shi, Osaka 540-6207, Japan</b>			
<b>Date of Registration</b>	12/03/2021		
<b>Title</b>	ELECTRIC MOTOR		
<b>Priority</b>			
<b>Priority Number</b>	<b>Date</b>	<b>Country</b>	
2020-019969	18/09/2020	Japan	

<b>Design Number</b>	379713-001	
<b>Class</b>	13-03	
<b>Brisk EV Energy Private Limited SY NO 201/2-2, B-2 Thokatta village Bowenpally Secundrabad Hyderabad 500011</b>		
<b>Date of Registration</b>	20/02/2023	
<b>Title</b>	JUNCTION BOX LOWER PART BODY	
<b>Priority NA</b>		

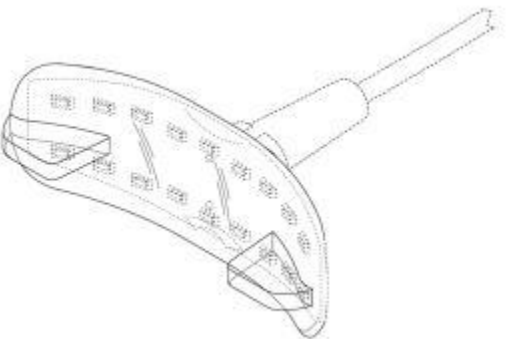
<b>Design Number</b>	331253-001	
<b>Class</b>	07-02	
<b>Bajaj Electricals Limited 45/47, Veer Nariman Road, Fort, Mumbai, Maharashtra - 400001.</b>		
<b>Date of Registration</b>	20/07/2020	
<b>Title</b>	GAS STOVE	
<b>Priority NA</b>		

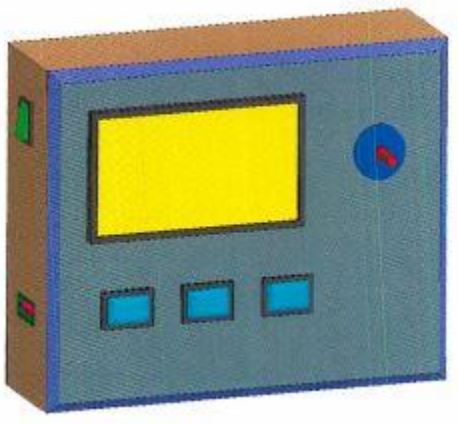
<b>Design Number</b>	373236-001	
<b>Class</b>	24-02	
<b>Colgate-Palmolive Company 300 Park Avenue, New York 10022, USA</b>		
<b>Date of Registration</b>	29/10/2022	
<b>Title</b>	Oral Cavity Treatment Device	
<b>Priority</b>		
<b>Priority Number</b>	<b>Date</b>	<b>Country</b>
29/837,094	02/05/2022	U.S.A.

Design Number	376542-001	
Class	10-05	
1. Sri Manakula Vinayagar Engineering College Madagadipet, Puducherry - 605 107, India 2. Dr. R. Raju Professor & Head, Department of Information Technology, Sri Manakula Vinayagar Engineering College, Madagadipet, Puducherry - 605 107, India 3. Dr. S. Balaji Associate Professor, Department of Information Technology, Sri Manakula Vinayagar Engineering College, Madagadipet, Puducherry - 605 107, India 4. Dr. R. Saravanan Associate Professor, Department of Information Technology, Sri Manakula Vinayagar Engineering College, Madagadipet, Puducherry - 605 107, India , et al.		
Date of Registration	02/01/2023	
Title	ELECTRIC VEHICLE ENERGY CONSUMPTION PREDICTING DEVICE	
Priority NA		

Design Number	379557-001	
Class	26-03	
Bajaj Electricals Limited 45/47, Veer Nariman Road, Fort, Mumbai - 400 001		
Date of Registration	17/02/2023	
Title	Street light	
Priority NA		

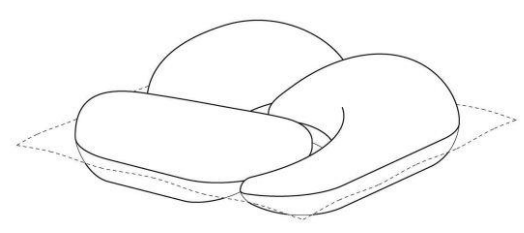
Design Number	322975-001	
Class	28-99	
The Procter & Gamble Company One Procter & Gamble Plaza, Cincinnati, OH 45202, United States of America		
Date of Registration	24/10/2019	
Title	UNIT DOSE POUCH	
Priority		
Priority Number	Date	Country
WIPO82970	26/04/2019	WIPO

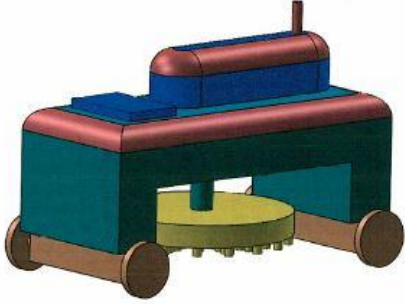
<b>Design Number</b>	376228-002	
<b>Class</b>	15-05	
<b>1. SIMATS SCHOOL OF ENGINEERING SIMATS SCHOOL OF ENGINEERING, SAVEETHA NAGAR, THANDALAM, CHENNAI-602105, TAMILNADU, INDIA 2. AJAY R AJAY R, DEPARTMENT OF COMPUTER SCIENCE AND ENGINEERING, SIMATS SCHOOL OF ENGINEERING, SAVEETHA NAGAR, THANDALAM, CHENNAI-602105, TAMILNADU, INDIA 3. DR G ANANDA KUMAR DR G ANANDA KUMAR, DEPARTMENT OF ENERGY AND ENVIRONMENTAL ENGINEERING, SIMATS SCHOOL OF ENGINEERING, SAVEETHA NAGAR, THANDALAM, CHENNAI-602105, TAMILNADU, INDIA 4. DR DEEPAK NALLASWAMY V DR DEEPAK NALLASWAMY V, DEPARTMENT OF PROSTHODONTICS, SAVEETHA DENTAL COLLEGE AND HOSPITAL, NO 162, POONAMALLEE HIGH ROAD, VELAPPANCHAVADI, CHENNAI-600077, TAMILNADU, INDIA , et al.</b>		
<b>Date of Registration</b>	27/12/2022	
<b>Title</b>	SMART FLOOR CLEANING ROBOT	
<b>Priority NA</b>		

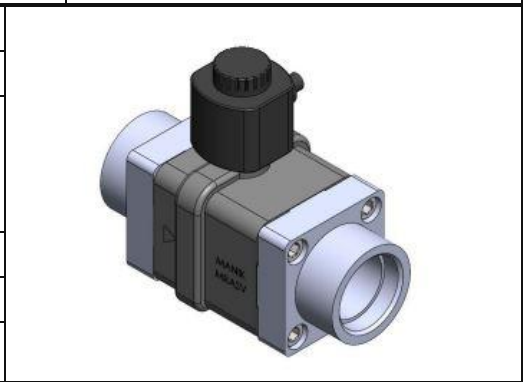

<b>Design Number</b>	378522-001
<b>Class</b>	23-01
<b>1. TEJASHREE TEJAS KULKARNI Flat no. 3, Malati Apartments, Girija Society, Kothrud, Pune - 411038, Maharashtra, India 2. PADMANABH SHEKHAR KULKARNI 401, Sindh Society, Baner Road, Aundh, Pune - 411007, Maharashtra, India.</b>	
<b>Date of Registration</b>	02/02/2023
<b>Title</b>	Solenoid Valve with coil
<b>Priority NA</b>	



<b>Design Number</b>	379702-001	
<b>Class</b>	12-16	
<b>Suzuki Motor Corporation 300 Takatsuka-cho, Minami-ku, Hamamatsu-shi, Shizuoka 432-8611, Japan</b>		
<b>Date of Registration</b>	20/02/2023	
<b>Title</b>	Grill for Automobile	
<b>Priority</b>		
<b>Priority Number</b>	<b>Date</b>	<b>Country</b>
2022-027163	19/12/2022	Japan

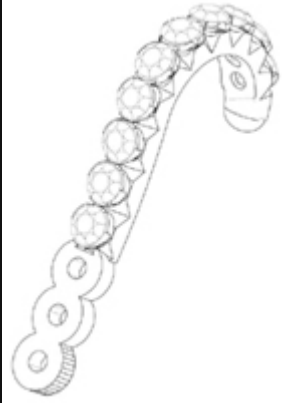
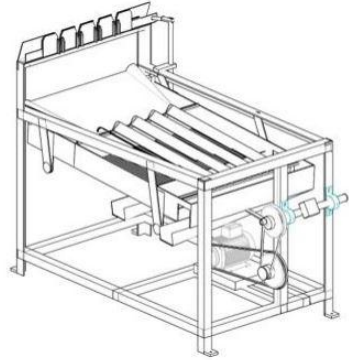

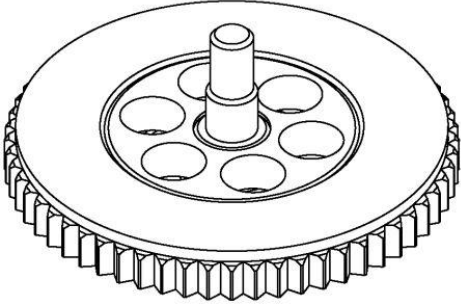
<b>Design Number</b>	378953-001		
<b>Class</b>	16-06		
<b>1. Ms. S. RAJALAKSHMI Associate Professor, Department of Computer Science and Engineering, Sri Venkateswara College of Engineering, Pennalur, Sriperumbudur, Tamil Nadu - 602117, India. 2. Ms. J. BUVANA Assistant Professor, Department of Computer Science and Engineering, Sri Venkateswara College of Engineering, Pennalur, Sriperumbudur, Tamil Nadu - 602117, India. 3. Ms. S. KALAVATHI Assistant Professor, Department of Information and Technology, Sri Venkateswara College of Engineering, Pennalur, Sriperumbudur, Tamil Nadu - 602117, India. 4. Dr. V. M. SIVAGAMI Professor, Department of Information and Technology, Sri Venkateswara College of Engineering, Pennalur, Sriperumbudur, Tamil Nadu - 602117, India. , et al.</b>			
<b>Date of Registration</b>	09/02/2023		
<b>Title</b>	Augmented Reality Glasses for Skin Cancer Classification		
<b>Priority NA</b>			
<b>Design Number</b>	325876-001		
<b>Class</b>	11-01		
<b>Venus by Maria Tash, Inc. a company of USA 653 Broadway, New York, New York 10012, USA.</b>			
<b>Date of Registration</b>	14/01/2020		
<b>Title</b>	EARRING		
<b>Priority</b>			
<b>Priority Number</b>	<b>Date</b>	<b>Country</b>	
29/698,281	16/07/2019	U.S.A.	
<b>Design Number</b>	339194-001		
<b>Class</b>	15-99		
<b>CHAUDHARY CHARAN SINGH HARYANA AGRICULTURAL UNIVERSITY Hisar-125004, Haryana, India</b>			
<b>Date of Registration</b>	16/02/2021		
<b>Title</b>	GARLIC STALK CUTTER CUM GRADER MACHINE		
<b>Priority NA</b>			

<b>Design Number</b>	379415-001		
<b>Class</b>	10-06		
<b>1.DR.T.NALLUSAMY DIRECTOR, CAREER DEVELOPMENT CENTER, J.J.GROUP OF INSTITUTIONS, TRICHY – DT, TAMILNADU-620009 2. Ms . DIANA EARSHIA V ASSISTANT PROFESSOR, ELECTRONICS AND COMMUNICATION , VEL TECH RANGARAJAN DR SAGUNTHALA R&amp;D INSTITUTE OF SCIENCE AND TECHNOLOGY, CHENNAI-600 062, TAMILNADU 3. Ms.P.Mohana Sunthari Assistant Professor, Electronics and Communication Engineering, K S R INSTITUTE FOR ENGINEERING AND TECHNOLOGY, NAMAKKAL, TAMILNADU-637215 4. Dr. Jenifer Mahilraj Associate Professor, Computer Science and Engineering, NPR College of Engineering, Natham,dindigul, Tamilnadu-624401 , et al.</b>			
<b>Date of Registration</b>	16/02/2023		
<b>Title</b>	ANTENNA SIGNAL MONITORING DEVICE		
<b>Priority NA</b>			
<b>Design Number</b>	342649-001		
<b>Class</b>	14-03		
<b>GIGALANE Co., Ltd. 61, Dongtansandan 10-gil, Dongtan-myeon, Hwaseong-si, Gyeonggi-do, Republic of Korea</b>			
<b>Date of Registration</b>	23/04/2021		
<b>Title</b>	Signal Transmission Connector		
<b>Priority</b>			
Priority Number	Date	Country	
30-2021-0003039	20/01/2021	Republic of Korea	
<b>Design Number</b>	378803-001		
<b>Class</b>	11-01		
<b>SABYASACHI CALCUTTA LLP 80/2 Topsia Road (South), Kolkata-700046, West Bengal.</b>			
<b>Date of Registration</b>	06/02/2023		
<b>Title</b>	JEWELLERY		
<b>Priority NA</b>			

<b>Design Number</b>	380393-001	
<b>Class</b>	02-05	
<b>SABYASACHI CALCUTTA LLP 80/2 Topsia Road (South), Kolkata-700046, West Bengal.</b>		
<b>Date of Registration</b>	28/02/2023	
<b>Title</b>	SHAWL	
<b>Priority NA</b>		
<b>Design Number</b>	378886-001	
<b>Class</b>	23-01	
<b>Pushpendra Patel 60 RAMBALI NAGAR, KILA MAIDAN ROAD, INDORE, Indore, Madhya Pradesh, 452006</b>		
<b>Date of Registration</b>	07/02/2023	
<b>Title</b>	Water Purifying Installations	
<b>Priority NA</b>		
<b>Design Number</b>	379156-001	
<b>Class</b>	14-01	
<b>1. Dr. Kotadi Chinnaiah Associate Professor , Department of Computer Science &amp; Engineering, GH Rasoni Collage of Engineering, Nagpur-440016. 2. Dr Praveen Kumar Mannepalli Professor &amp; HOD, Department of Computer Science &amp; Engineering(Cyber Security), GH Rasoni Institute of Engineering and Technology, Nagpur-440016 3. Mr. Devidas Kanchetti Solution Architect, 3808 Fox Run Road, Matthews, State: North Carolina , Country : United States, Zip - 28104. 4. Prof. Priyanka Anup Ujjainkar Assistant Professor, Department of Artificial Intelligence, GH Rasoni Collage of Engineering, Nagpur-440016. , et al.</b>		
<b>Date of Registration</b>	12/02/2023	
<b>Title</b>	ARTIFICIAL INTELLIGENCE BASED SPEAKER FOR STORYTELLING	
<b>Priority NA</b>		

<b>Design Number</b>	323157-001	
<b>Class</b>	15-03	
<b>CNH Industrial (India) Private Limited Plot No. 14A, 3rd floor, Sector-18, Udyog Vihar, Gurgaon-122015, Haryana, India</b>		
<b>Date of Registration</b>	31/10/2019	
<b>Title</b>	SUGARCANE HARVESTER	
<b>Priority</b>		
Priority Number	Date	Country
BR 30 2019 002201 0	23/05/2019	Brazil

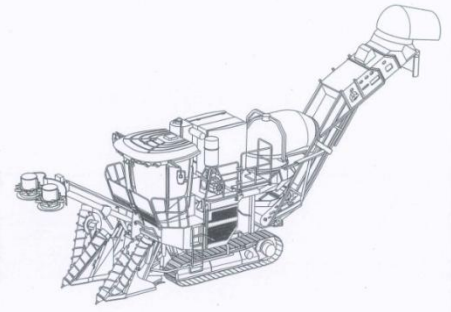

<b>Design Number</b>	379844-001	
<b>Class</b>	02-02	
<b>SABYASACHI CALCUTTA LLP 80/2 Topsia Road (South), Kolkata-700046, West Bengal.</b>		
<b>Date of Registration</b>	21/02/2023	
<b>Title</b>	LADIES GARMENT (SET)	
<b>Priority NA</b>		





<b>Design Number</b>	373992-001	
<b>Class</b>	10-05	
<p>1. Dr. P. PREETHI Department of Computer Science and Engineering, Kongunadu College of Engineering and Technology, Tholurpatti, Trichy-621215, Tamilnadu, India. 2. Mr. P. ASHOK Assistant Professor, Department of Computer Science and Engineering, Sri Sai Ram Institute of Technology, Sai Leo Nagar, Tambaram West, Chennai-600044, Tamilnadu, India 3. Dr. P. SHERUBHA Assistant Professor, Department of Information Technology, Karpagam College of Engineering, Myleripalayam Village, Othakkal Mandapam, Coimbatore-641032, Tamilnadu, India. 4. Mrs. V. SOWJANYA Assistant Professor, Department of AI &amp; DS, Lakireddy Balireddy College of Engineering L.B.Reddy Nagar, Mylavaram, Krishna (Dt.)-521230, Andhra Pradesh, India</p>		
<b>Date of Registration</b>	12/11/2022	
<b>Title</b>	Wearable Social Distance Alerting Device	
<b>Priority NA</b>		



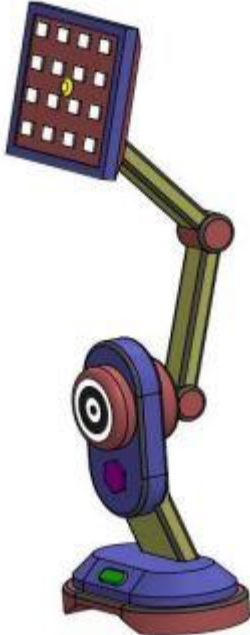

<b>Design Number</b>	379505-001	
<b>Class</b>	24-01	
<b>1.Mr. ATCHUTUNI V S RAVI SAI NADH KVSR SIDDHARTHA COLLEGE OF PHARMACEUTICAL SCIENCES, PINNAMANENI POLYCLINIC ROAD, SIDDHARTHA NAGAR, VIJAYAWADA-520010 2. Dr. K. RAVI SHANKAR KVSR SIDDHARTHA COLLEGE OF PHARMACEUTICAL SCIENCES, PINNAMANENI POLYCLINIC ROAD, SIDDHARTHA NAGAR, VIJAYAWADA-520010 3. Ms. L. DIVYA SAROJA KVSR SIDDHARTHA COLLEGE OF PHARMACEUTICAL SCIENCES, PINNAMANENI POLYCLINIC ROAD, SIDDHARTHA NAGAR, VIJAYAWADA-520010 4. Ms. Ch. PAVITRA KVSR SIDDHARTHA COLLEGE OF PHARMACEUTICAL SCIENCES, PINNAMANENI POLYCLINIC ROAD, SIDDHARTHA NAGAR, VIJAYAWADA-520010 , et al.</b>		
<b>Date of Registration</b>	16/02/2023	
<b>Title</b>	INTRACARDIAC OXIMETER	
<b>Priority NA</b>		
<b>Design Number</b>	378592-001	
<b>Class</b>	24-02	
<b>SENSA CORE MEDICAL INSTRUMENTATION PRIVATE LIMITED PLOT 3, EPIP, PASHAMYLARAM, HYDERABAD 502307, TELANGANA</b>		
<b>Date of Registration</b>	03/02/2023	
<b>Title</b>	MULTI-PARAMETER ELECTROLYTE ELECTRODE	
<b>Priority NA</b>		
<b>Design Number</b>	341658-001	
<b>Class</b>	23-07	
<b>Kohler Co. 444 Highland drive, Kohler, Wisconsin, USA 53044</b>		
<b>Date of Registration</b>	31/03/2021	
<b>Title</b>	WATER CLOSET	
<b>Priority NA</b>		

<b>Design Number</b>	377471-005	
<b>Class</b>	06-11	
<b>Amit Gupta Mohini Creations, Plot No. 4, Ganesh Vihar, Keshopura, Bhankrota, Jaipur, Rajasthan-302026, India</b>		
<b>Date of Registration</b>	16/01/2023	
<b>Title</b>	SHOOTING STAR PATTERN FLAT WEAVE RUG	
<b>Priority NA</b>		
<b>Design Number</b>	376295-001	
<b>Class</b>	09-01	
<b>K.K PRODUCT BHOOMI IND AREA-2, REVENUE SURVEY NO 247/1, PLOT NO 11, BEHIND HARGANGE WEIGH BRIDGE, NEAR PATEL PAN, VERAVAL-SHAPAR, RAJKOT-360024, GUJARAT, INDIA</b>		
<b>Date of Registration</b>	28/12/2022	
<b>Title</b>	"OIL DISPENSER"	
<b>Priority NA</b>		
<b>Design Number</b>	353670-001	
<b>Class</b>	14-06	
<b>Mr. Veera Venkata Sanjeeva Kumar Seekati Flat No-202, Block -3, Hari Villu Apartments, Opp. Gautami Talent School, Manikonda, Rajendra Nagar Mandal, Ranga Reddy, Telangana- 500075, India.</b>		
<b>Date of Registration</b>	25/11/2021	
<b>Title</b>	HOLDER FOR MOBILE TELEPHONE	
<b>Priority NA</b>		

<b>Design Number</b>	378936-001		
<b>Class</b>	14-02		
<b>1. Dr. Pratishtha Verma Assistant Professor at Jaypee Institute of Information and Technology, Noida, Uttar Pradesh 2. Dr. Ankita Verma Assistant Professor at Jaypee Institute of Information and Technology, Noida, Uttar Pradesh 3. Dr. Jyoti Singh Kirar Assistant Professor, BHU Varanasi, Uttar Pradesh 4. Dr. Savita Assistant Professor at gurukul kangri, Haridwar, Uttarakhand</b>			
<b>Date of Registration</b>	08/02/2023		
<b>Title</b>	MACHINE LEARNING BASED CONFIDENCE TRACKING DEVICE OF THE EMPLOYEE		
<b>Priority NA</b>			
<b>Design Number</b>	338542-001		
<b>Class</b>	13-03		
<b>DANFOSS POWER ELECTRONICS A/S Ulsnæs 1 DK-6300 Gråsten Denmark</b>			
<b>Date of Registration</b>	03/02/2021		
<b>Title</b>	FREQUENCY CONVERTER		
<b>Priority</b>			
<b>Priority Number</b>	<b>Date</b>	<b>Country</b>	
008073407-0007	04/08/2020	EUIPO	
<b>Design Number</b>	376533-002		
<b>Class</b>	02-02		
<b>Piyush Parshottambhai Limbasiya 61, Anand Dhara Row House-2, Mota Varachha, Surat-394101, Gujarat, India</b>			
<b>Date of Registration</b>	02/01/2023		
<b>Title</b>	SAREE		
<b>Priority NA</b>			

<b>Design Number</b>	337132-001	
<b>Class</b>	24-02	
<b>INSTIL BIO (UK) LIMITED 48 Grafton Street, Manchester, M13 9XX, United Kingdom</b>		
<b>Date of Registration</b>	01/01/2021	
<b>Title</b>	TISSUE COLLECTION BAG FOR SEALING TISSUE THEREIN FOR PROCESSING	
<b>Priority</b>		
Priority Number	Date	Country
29/740,293	02/07/2020	U.S.A.

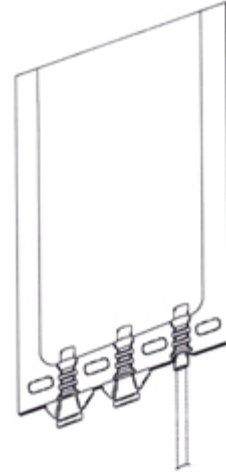





<b>Design Number</b>	363922-001	
<b>Class</b>	10-04	
<b>Microanalytik Instruments Private Limited 210 E Bldg. No.A 3, Pala, Empire Industrial Centrum 2 Nd Floor Kalyan Badalapur Road Ambernath Thane Maharashtra 421501</b>		
<b>Date of Registration</b>	09/05/2022	
<b>Title</b>	Spectrometer	
<b>Priority NA</b>		

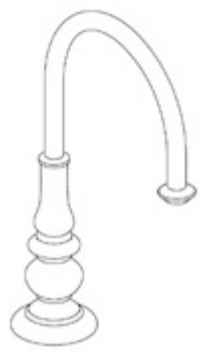
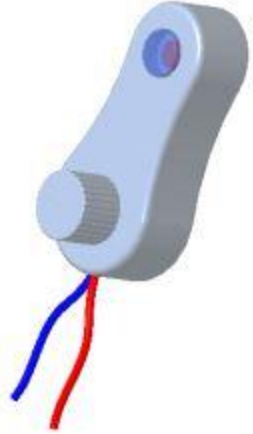

<b>Design Number</b>	379460-001	
<b>Class</b>	02-02	
<b>1. Gurkiran Kaur Lecturer, Dept. of Textile Design and Apparel Technology, Kanya Maha Vidyalaya, Jalandhar, Punjab Pin – 144004 India 2. Vibhuti Kalia Assistant Professor, Dept. of Textile Design and Apparel Technology, Kanya Maha Vidyalaya, Jalandhar, Punjab Pin – 144004 India</b>		
<b>Date of Registration</b>	16/02/2023	
<b>Title</b>	DRESS	
<b>Priority NA</b>		

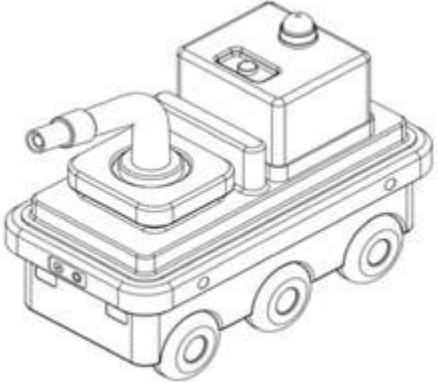
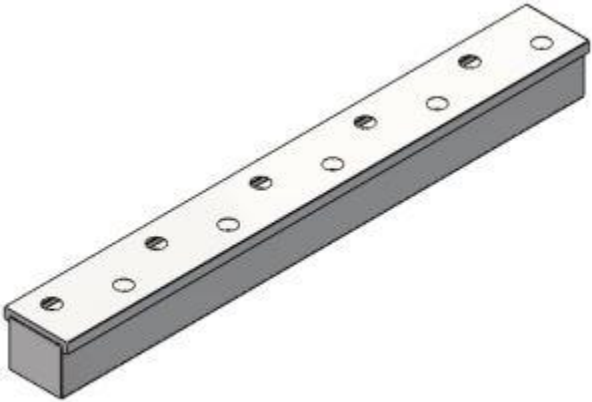

<b>Design Number</b>	327622-001		
<b>Class</b>	23-01		
<b>Kohler Co., 444 Highland Drive, Kohler, WI 53044, United States of America</b>			
<b>Date of Registration</b>	27/02/2020		
<b>Title</b>	FAUCET		
<b>Priority</b>			
Priority Number	Date	Country	
29/703,821	29/08/2019	U.S.A.	
<b>Design Number</b>	378817-001		
<b>Class</b>	10-05		
<b>1. Dr . K.Suneeta Professor , Electrical and Electronics Engineering , Pallavi Engineering College , Hyderabad , Telangana - 501505 2. Dr. V.KANNAN MANAGING DIRECTOR, CLDC RESEARCH AND DEVELOPMENT NO.997, METTUPALAYAM ROAD, NEAR X-CUT SIGNAL,R.S.PURAM, COIMBATORE-641002. TAMIL NADU 3. Dr . Revathy M Assistant Professor , Mathematics, KPR College of Arts Science and Research , Coimbatore, Tamil Nadu-641 407 4. Dr Kishore B Assistant Professor (Selection Grade), EEE, , Dr Mahalingam College of Engineering and Technology, Pollachi – 642003, Tamilnadu , et al.</b>			
<b>Date of Registration</b>	07/02/2023		
<b>Title</b>	IOT solar streetlight Controller device		
<b>Priority NA</b>			
<b>Design Number</b>	343852-001		
<b>Class</b>	24-01		
<b>KONINKLIJKE PHILIPS N.V. Eindhoven, whose post-office address is High Tech Campus 52, 5656 AG Eindhoven, The Netherlands,</b>			
<b>Date of Registration</b>	25/05/2021		
<b>Title</b>	ULTRASOUND DEVICE		
<b>Priority</b>			
Priority Number	Date	Country	
008308159-0001	04/12/2020	EUIPO	

<b>Design Number</b>	357709-001	
<b>Class</b>	24-01	
<b>1. Dr. P. Asha Associate Professor, Department of Computer Science and Engineering, Sathyabama Institute of Science and Technology, Jeppiaar Nagar, Rajiv Gandhi Salai, Chennai - 600119 2. Dr. B. Anayarkanni Associate Professor, Department of Computer Science and Engineering, Sathyabama Institute of Science and Technology, Jeppiaar Nagar, Rajiv Gandhi Salai, Chennai - 600119 3. Dr. A. Mary Posonia Associate Professor, Department of Computer Science and Engineering, Sathyabama Institute of Science and Technology, Jeppiaar Nagar, Rajiv Gandhi Salai, Chennai - 600119 4. Dr. J. Albert Mayan Associate Professor, Department of Computer Science and Engineering, Sathyabama Institute of Science and Technology, Jeppiaar Nagar, Rajiv Gandhi Salai, Chennai - 600119</b>		
<b>Date of Registration</b>	01/02/2022	
<b>Title</b>	“A SANITIZING ROBOT”	
<b>Priority NA</b>		
<b>Design Number</b>	378320-001	
<b>Class</b>	09-03	
<b>EEKI AUTOMATION PRIVATE LIMITED E-44 GYAN SAROVAR COLONY, KOTA BUNDI ROAD, KUNHARI, KOTA-324008</b>		
<b>Date of Registration</b>	31/01/2023	
<b>Title</b>	PLANT ROOT ZONE CHAMBER	
<b>Priority NA</b>		
<b>Design Number</b>	376561-001	
<b>Class</b>	09-09	
<b>1. Pandit Deendayal Energy University Raisan Village, Gandhinagar-382007, Gujarat, India. 2. Dr. S. Sundar Manoharan Director General, Pandit Deendayal Energy University, Raisan Village, Gandhinagar-382007, Gujarat, India 3. Dr. D. Sivaraman Assistant Professor, Pandit Deendayal Energy University, Raisan Village, Gandhinagar-382007, Gujarat, India 4. Dr. P.S. Pradeep Assistant Professor, MECH, Pandit Deendayal Energy University, Raisan Village, Gandhinagar-382007, Gujarat, India , et al.</b>		
<b>Date of Registration</b>	02/01/2023	
<b>Title</b>	REMOTE OPERABLE MEDICAL WASTE COLLECTING BIN WITH UV LIGHT STERILIZER	
<b>Priority NA</b>		

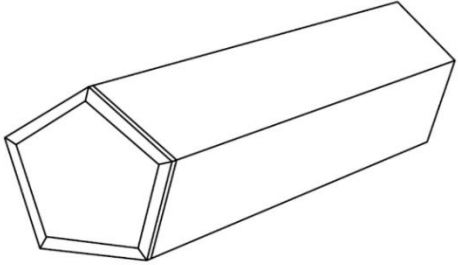

<b>Design Number</b>	379380-001	
<b>Class</b>	14-01	
<b>Heinrich Corporation India Private Limited A-62, 1st Floor, DDA Sheds, Okhla Industrial Area, Phase II, New Delhi - 110020</b>		
<b>Date of Registration</b>	15/02/2023	
<b>Title</b>	WALL MOUNTED SPEAKER	
<b>Priority NA</b>		

<b>Design Number</b>	341770-001	
<b>Class</b>	23-01	
<b>FABIO AND MARKUS COLLOID ENGINEERING GMBH Kantonsstrasse 35, CH 8807 Freienbach Switzerland</b>		
<b>Date of Registration</b>	01/04/2021	
<b>Title</b>	WATER PURIFIER	
<b>Priority</b>		
<b>Priority Number</b>	<b>Date</b>	<b>Country</b>
DM/210754	03/10/2020	WIPO

<b>Design Number</b>	378525-001	
<b>Class</b>	23-01	
<b>1. TEJASHREE TEJAS KULKARNI Flat no. 3, Malati Apartments, Girija Society, Kothrud, Pune - 411038, Maharashtra, India 2. PADMANABH SHEKHAR KULKARNI 401, Sindh Society, Baner Road, Aundh, Pune - 411007, Maharashtra, India.</b>		
<b>Date of Registration</b>	02/02/2023	
<b>Title</b>	Capacity Loading Valve for Compressor with Coil	
<b>Priority NA</b>		

<b>Design Number</b>	361951-001		
<b>Class</b>	09-01		
<b>SERVAM MARKETING SOLUTION PRIVATE LIMITED D-1, MEERUT ROAD, INDUSTRIAL AREA, GHAZIBAD-201003</b>			
<b>Date of Registration</b>	05/04/2022		
<b>Title</b>	BOTTLE		
<b>Priority NA</b>			
<b>Design Number</b>	377384-001		
<b>Class</b>	07-10		
<b>Hamilton Housewares Pvt. Ltd. Kaise-I-Hind Building, 3rd Floor, Currimbhoy Rd, Ballard Estate, Fort, Mumbai, Maharashtra 400001, India</b>			
<b>Date of Registration</b>	13/01/2023		
<b>Title</b>	INSULATED BOTTLES		
<b>Priority NA</b>			
<b>Design Number</b>	341976-001		
<b>Class</b>	23-01		
<b>Viking Group, Inc. 5150 Beltway SE, Caledonia, MI 49316 United States Of America</b>			
<b>Date of Registration</b>	06/04/2021		
<b>Title</b>	COVER OF A FLUID CONTROL VALVE ASSEMBLY FOR FIRE PROTECTION SYSTEMS		
<b>Priority</b>			
<b>Priority Number</b>	<b>Date</b>	<b>Country</b>	
29/754,351	09/10/2020	U.S.A.	

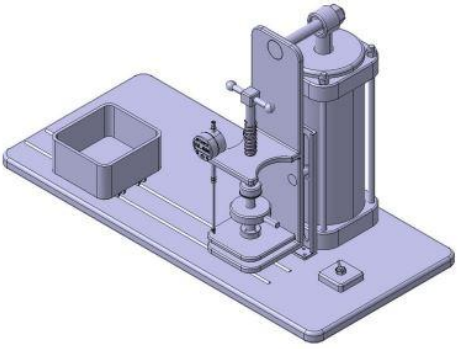



<b>Design Number</b>	362142-001	
<b>Class</b>	03-01	
<b>Safari Industries (India) Limited 302-303, A-Wing, The Qube, CTS No. 1498, A/2, M.V Road, Marol, Andheri (East), Mumbai - 400 059</b>		
<b>Date of Registration</b>	07/04/2022	
<b>Title</b>	SUITCASE	
<b>Priority NA</b>		
<b>Design Number</b>	379340-001	
<b>Class</b>	10-05	
<b>AMARA RAJA BATTERIES LIMITED f Karakambadi-517 520, Tirupati, Andhra Pradesh, India.</b>		
<b>Date of Registration</b>	15/02/2023	
<b>Title</b>	ACID RETENTION UNDER COMPRESSION AND RESILIENCE INSTRUMENT FOR AGM SEPARATORS	
<b>Priority NA</b>		
<b>Design Number</b>	365466-001	
<b>Class</b>	12-16	
<b>TVS Motor Company Limited "Chaitanya", No.12 Khader Nawaz Khan Road, Nungambakkam, Chennai 600 006</b>		
<b>Date of Registration</b>	05/06/2022	
<b>Title</b>	Heel guard	
<b>Priority NA</b>		

<b>Design Number</b>	333463-001		
<b>Class</b>	14-01		
<b>Flare Audio Technologies Limited Unit 11, Chartwell Business Centre 42 Chartwell Road, Lancing Business Park Lancing, West Sussex BN15 8FB, United Kingdom</b>			
<b>Date of Registration</b>	22/09/2020		
<b>Title</b>	Earphone		
<b>Priority</b>			
Priority Number	Date	Country	
GB6100944	18/09/2020	U.K.	

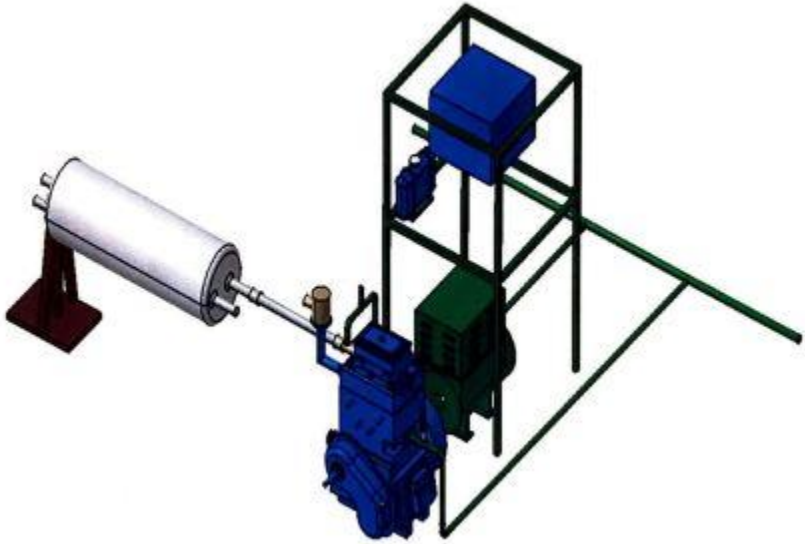

<b>Design Number</b>	349735-001		
<b>Class</b>	21-02		
<b>YONEX KABUSHIKI KAISHA 23-13, Yushima 3-Chome, Bunkyo-ku, Tokyo Japan</b>			
<b>Date of Registration</b>	19/09/2021		
<b>Title</b>	Badminton Racket Frame		
<b>Priority NA</b>			



<b>Design Number</b>	374118-001		
<b>Class</b>	15-01		
<p>1. Dr. Abhijit Dey Assistant professor, Department of Mechanical Engineering, National Institute of Technology Srinagar, Jammu &amp; Kashmir - 190006</p> <p>2. Dr. Amit Kumar Dey Assistant professor, Department of Civil Engineering, Central Institute of Technology Kokhrajhar, BTAD, Assam - 783370</p> <p>3. Dr. Mohammad Mohsin Khan Assistant professor, Department of Mechanical Engineering, National Institute of Technology Srinagar, Jammu &amp; Kashmir - 190006</p> <p>4. Prof. Ramesh Chandra Panda Chief Scientist Wegrow Private limited Bhubaneswar Odisha - 751001</p>			
<b>Date of Registration</b>	14/11/2022		
<b>Title</b>	Biodiesel Operating Engine		
<b>Priority NA</b>			



<b>Design Number</b>	379448-001	
<b>Class</b>	12-08	
<b>1.DR. KEDARI LAL DHAKAD ASSISTANT PROFESSOR (SENIOR GRADE) MECHANICAL ENGINEERING JAYPEE UNIVERSITY OF ENGINEERING AND TECHNOLOGY, A-B ROAD, RAGHOGARH, DISTT. - GUNA (M.P.), PIN - 473226, INDIA 2. Dr. AMIT KUMAR ASSISTANT PROFESSOR (SENIOR GRADE) COMPUTER SCIENCE AND ENGINEERING JAYPEE UNIVERSITY OF ENGINEERING AND TECHNOLOGY, A-B ROAD, RAGHOGARH, DISTT. - GUNA (M.P.), PIN - 473226, INDIA 3. Dr. DINESH KUMAR VERMA ASSISTANT PROFESSOR (SENIOR GRADE) COMPUTER SCIENCE AND ENGINEERING JAYPEE UNIVERSITY OF ENGINEERING AND TECHNOLOGY, A-B ROAD, RAGHOGARH, DISTT. - GUNA (M.P.), PIN - 473226, INDIA 4. Dr. PRATEEK PANDEY ASSISTANT PROFESSOR (SENIOR GRADE) COMPUTER SCIENCE AND ENGINEERING JAYPEE UNIVERSITY OF ENGINEERING AND TECHNOLOGY, A-B ROAD, RAGHOGARH, DISTT. - GUNA (M.P.), PIN - 473226, INDIA , et al.</b>		
<b>Date of Registration</b>	16/02/2023	
<b>Title</b>	SOLAR POWERED SECURE INTELLIGENT AUTOMOBILE VEHICLE	
<b>Priority NA</b>		
<b>Design Number</b>	375198-009	
<b>Class</b>	11-01	
<b>Aulyra Design Private Limited 3rd floor, Plot No. 3807, Phase 4, Chakkarpur, Gurugram, Haryana – 122001</b>		
<b>Date of Registration</b>	07/12/2022	
<b>Title</b>	Ring	
<b>Priority NA</b>		
<b>Design Number</b>	377558-002	
<b>Class</b>	31-00	
<b>Ekta Plastics Q5, Quresh Compound, Chinchoti, Kaman Road, Vasai-Virar, Palghar - 401 208, Maharashtra, India, Proprietor is Ekta Shah</b>		
<b>Date of Registration</b>	17/01/2023	
<b>Title</b>	BODY OF MIXER GRINDER	
<b>Priority NA</b>		

<b>Design Number</b>	358814-001	
<b>Class</b>	09-01	
<b>Mr. Sandeep Patidar 128, Bardana Mandi, Palda, Indore - 452001 (M.P.).</b>		
<b>Date of Registration</b>	18/02/2022	
<b>Title</b>	BOTTLE	
<b>Priority NA</b>		
<b>Design Number</b>	358569-003	
<b>Class</b>	09-04	
<b>Alkon Plastics Pvt. Ltd. 801, 8th Floor, Embassy Chambers, 3rd Road, Khar (West), Mumbai : 400052, Maharashtra, India</b>		
<b>Date of Registration</b>	15/02/2022	
<b>Title</b>	CRATE	
<b>Priority NA</b>		
<b>Design Number</b>	376533-003	
<b>Class</b>	02-02	
<b>Piyush Parshottambhai Limbasiya 61, Anand Dhara Row House-2, Mota Varachha, Surat-394101, Gujarat, India</b>		
<b>Date of Registration</b>	02/01/2023	
<b>Title</b>	SAREE	
<b>Priority NA</b>		



<b>Design Number</b>	351205-001	
<b>Class</b>	13-03	
<b>M/s Goldmedal Electricals Private Limited A-302, Kemp Plaza, Mind Space, Chincholi Bunder, Off Link Road, Malad West, Mumbai – 400 064</b>		
<b>Date of Registration</b>	12/10/2021	
<b>Title</b>	SWITCH PLATE	
<b>Priority NA</b>		
<b>Design Number</b>	358626-001	
<b>Class</b>	12-05	
<b>Godrej &amp; Boyce Mfg. Co. Ltd. Godrej &amp; Boyce Pirojshanagar, Vikhroli (W), Mumbai, Maharashtra, India-400079.</b>		
<b>Date of Registration</b>	15/02/2022	
<b>Title</b>	Reach Truck	
<b>Priority NA</b>		
<b>Design Number</b>	341062-001	
<b>Class</b>	06-03	
<b>SKI Plastoware Pvt. Ltd. 8/A, Minerva Ind. Estate, Opp. Asha Nagar, Near P&amp;T Colony, Next to Victoria Classic, Mulund West, Mumbai 400080</b>		
<b>Date of Registration</b>	19/03/2021	
<b>Title</b>	FOLDING TABLE	
<b>Priority NA</b>		

<b>Design Number</b>	379647-001		
<b>Class</b>	02-02		
<b>SABYASACHI CALCUTTA LLP 80/2 Topsia Road (South), Kolkata-700046, West Bengal.</b>			
<b>Date of Registration</b>	18/02/2023		
<b>Title</b>	LADIES GARMENT (SET)		
<b>Priority NA</b>			
<b>Design Number</b>	341811-001		
<b>Class</b>	24-02		
<b>PHILLIPS-MEDISIZE A/S Gimsinglundvej 20, 7600 Struer, Denmark</b>			
<b>Date of Registration</b>	02/04/2021		
<b>Title</b>	Autoinjector		
<b>Priority</b>			
<b>Priority Number</b>	<b>Date</b>	<b>Country</b>	
29/753858	02/10/2020	U.S.A.	
<b>Design Number</b>	375327-001		
<b>Class</b>	02-02		
<b>SABYASACHI CALCUTTA LLP 80/2 Topsia Road (South), Kolkata-700046, West Bengal.</b>			
<b>Date of Registration</b>	09/12/2022		
<b>Title</b>	GARMENT		
<b>Priority NA</b>			

<b>Design Number</b>	379168-001	
<b>Class</b>	09-01	
<b>1. Dr. Shailesh Sharma Amar Shaheed Baba Ajit Singh Jujhar Singh Memorial College of Pharmacy, Bela (Ropar), Punjab-140111</b> <b>2. Dr. Neelam Sharma Amar Shaheed Baba Ajit Singh Jujhar Singh Memorial College of Pharmacy, Bela (Ropar), Punjab-140111</b> <b>3. Dr. Rahul Kumar Sharma Amar Shaheed Baba Ajit Singh Jujhar Singh Memorial College of Pharmacy, Bela (Ropar), Punjab-140111</b> <b>4. Ms. Punam Gaba Amar Shaheed Baba Ajit Singh Jujhar Singh Memorial College of Pharmacy, Bela (Ropar), Punjab-140111</b> , et al.		
<b>Date of Registration</b>	13/02/2023	
<b>Title</b>	Re-Sizable Multipurpose Flasket	
<b>Priority NA</b>		
<b>Design Number</b>	376753-002	
<b>Class</b>	23-04	
<b>M/S Meghdoot Industries 533/2, Mundka, Mundka Indl Area, Delhi-110041, India,</b> <b>Proprietor is Anil Katyal</b>		
<b>Date of Registration</b>	05/01/2023	
<b>Title</b>	AIR COOLER	
<b>Priority NA</b>		
<b>Design Number</b>	377675-001	
<b>Class</b>	23-07	
<b>Kiran Refractories Tarnetar Road, Thangadh, Surendranagar, Gujarat-363530,</b> <b>India.,</b>		
<b>Date of Registration</b>	19/01/2023	
<b>Title</b>	COMMODE	
<b>Priority NA</b>		

<b>Design Number</b>	377364-001	
<b>Class</b>	23-04	
<b>M/S Ecco Cool Home Appliances House No. 56, Shani Gate, Maliwara, Ghaziabad, Uttarpradesh-201001, India, Partners are Pradeep Kumar, Manjeet Singh</b>		
<b>Date of Registration</b>	13/01/2023	
<b>Title</b>	AIR COOLER.	
<b>Priority NA</b>		
<b>Design Number</b>	346775-001	
<b>Class</b>	07-05	
<b>1. CHITKARA INNOVATION INCUBATOR FOUNDATION SCO: 160-161, SECTOR -9C, MADHYA MARG, CHANDIGARH- 160009, INDIA. 2. PARAMBIR SINGH CHITKARA UNIVERSITY, CHANDIGARH-PATIALA NATIONAL HIGHWAY (NH- 64), VILLAGE, JANSLA, RAJPURA, PUNJAB 140401, INDIA. 3. ANOOP KUMAR SINGH CHITKARA UNIVERSITY, CHANDIGARH-PATIALA NATIONAL HIGHWAY (NH- 64), VILLAGE, JANSLA, RAJPURA, PUNJAB 140401, INDIA. 4. GURDYAL SINGH CHITKARA UNIVERSITY, CHANDIGARH-PATIALA NATIONAL HIGHWAY (NH- 64), VILLAGE, JANSLA, RAJPURA, PUNJAB 140401, INDIA. , et al.</b>		
<b>Date of Registration</b>	26/07/2021	
<b>Title</b>	MOTORIZED TELESCOPIC WINDOW WIPER	
<b>Priority NA</b>		
<b>Design Number</b>	379636-001	
<b>Class</b>	02-02	
<b>SABYASACHI CALCUTTA LLP 80/2 Topsia Road (South), Kolkata-700046, West Bengal.</b>		
<b>Date of Registration</b>	18/02/2023	
<b>Title</b>	LADIES GARMENT	
<b>Priority NA</b>		

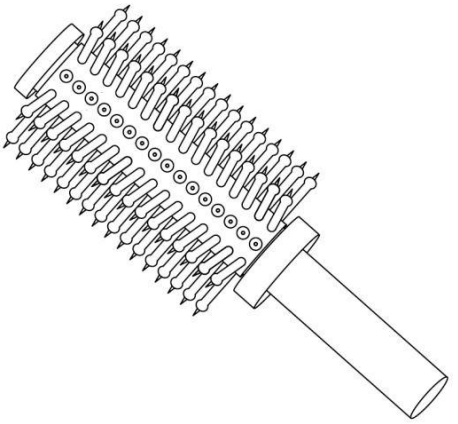

<b>Design Number</b>	378546-001	
<b>Class</b>	24-02	
<b>1. Dr. Kumara Swamy Jella Professor, Department of Chemistry, Chaitanya (Deemed to be University), Hanamkonda, Telangana State - 506001, India. 2. Dr. Manisha Atul Bora Associate Professor in Chemistry, B.J.S.'S Arts, Science &amp; Commerce College, Wagholi, Pune, Maharashtra, India. 412207, Affiliated to S. P. Pune University. 3. Dr. Sujeet Suryakant Jadhav Asst. Prof., Head Department of Botany, S. B. R. College Mhaswad Tal. Man, Dist. Satara, Maharashtra, India. 4. Dr. S.Sarojini Prof.Cum Principal. HOD, Department of Pharmaceutics, Shri Venkateshwara College of Pharmacy, Ariyur, Puducherry-605102, India , et al.</b>		
<b>Date of Registration</b>	03/02/2023	
<b>Title</b>	CONTROLLED MEDICATION DISCHARGING DEVICE	
<b>Priority NA</b>		
<b>Design Number</b>	378707-001	
<b>Class</b>	15-03	
<b>Jangeer Manufacturing Industries Private Limited Near New Dhan Mandi, Anoopgarh Road, Raisinghnagar, (Distt. Sri Ganganagar) Rajasthan.</b>		
<b>Date of Registration</b>	06/02/2023	
<b>Title</b>	THRESHER PARTS	
<b>Priority NA</b>		
<b>Design Number</b>	379548-001	
<b>Class</b>	24-02	
<b>Dr. Laxmikant Kamudas Desai B-101, Rosary Apartments, Uday Baug, Ghorphadi Gaon, Pune - 411001, Maharashtra, India</b>		
<b>Date of Registration</b>	17/02/2023	
<b>Title</b>	Roller Comb with Needles for Improvising Hair loss Treatment	
<b>Priority NA</b>		

<b>Design Number</b>	377816-001	
<b>Class</b>	12-11	
<b>Jindal Mobilitric Private Limited UL/8, Suryarath, B/H Center Point, Panchvati, Ahmedabad, Gujarat, 380006</b>		
<b>Date of Registration</b>	23/01/2023	
<b>Title</b>	ELECTRIC TWO WHEELER	
<b>Priority NA</b>		

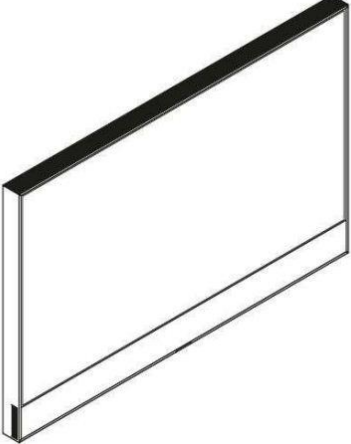

<b>Design Number</b>	378120-001	
<b>Class</b>	15-07	
<b>Blue Star Limited Kasturi Buildings, Mohan T. Advani Chowk, Jamshedji Tata Road, Mumbai 400 020</b>		
<b>Date of Registration</b>	27/01/2023	
<b>Title</b>	DEEP FREEZER	
<b>Priority NA</b>		

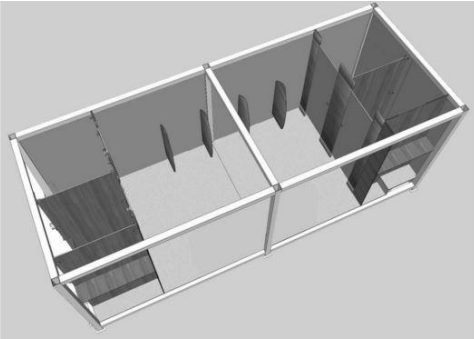

<b>Design Number</b>	361280-001		
<b>Class</b>	14-03		
<b>SKY CP LIMITED Grant Way, Isleworth TW7 5QD Middlesex, UNITED KINGDOM</b>			
<b>Date of Registration</b>	25/03/2022		
<b>Title</b>	TELEVISION		
<b>Priority</b>			
<b>Priority Number</b>	<b>Date</b>		<b>Country</b>
6165976	28/09/2021		U.K.

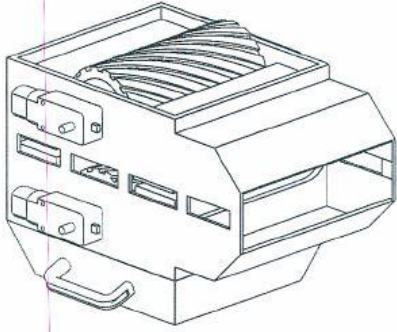

<b>Design Number</b>	357398-001		
<b>Class</b>	01-01		
<b>FRITO-LAY NORTH AMERICA, Inc. 7701 Legacy Drive, Plano, TEXAS, Postal Code 75024, United States of America.</b>			
<b>Date of Registration</b>	27/01/2022		
<b>Title</b>	SNACK FOOD PRODUCT		
<b>Priority</b>			
Priority Number	Date	Country	
29/802,292	04/08/2021	U.S.A.	

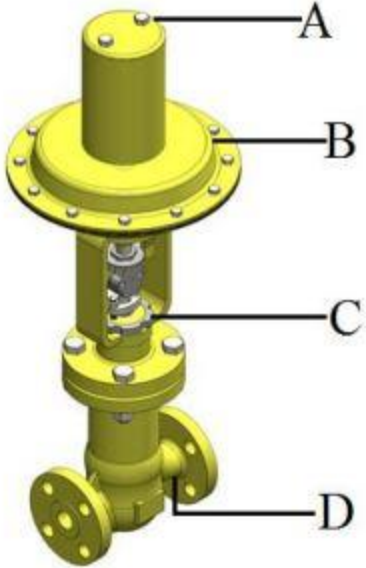

<b>Design Number</b>	333936-001		
<b>Class</b>	25-02		
<b>TATA STEEL LIMITED Jamshedpur, – 831 001, Jharkhand, India</b>			
<b>Date of Registration</b>	06/10/2020		
<b>Title</b>	PREFABRICATED TOILET		
<b>Priority NA</b>			

<b>Design Number</b>	377042-001		
<b>Class</b>	23-03		
<b>Kamalkishor N. Laddha "PADMAREKHA" 26, Vasant Nagar, Jawahar Colony, Trimurti Chowk, Near Saibaba Mandir, Aurangabad - 431005 (Maharashtra)</b>			
<b>Date of Registration</b>	09/01/2023		
<b>Title</b>	WATER HEATER		
<b>Priority NA</b>			

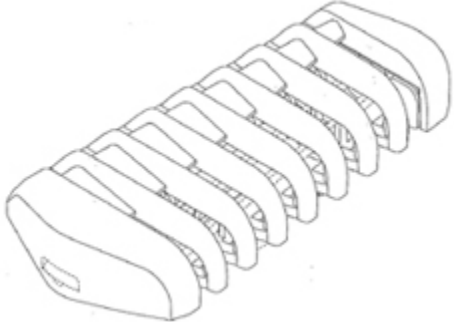
<b>Design Number</b>	378044-001	
<b>Class</b>	23-04	
<b>M/S SUMMERCOOL HOME APPLIANCES LIMITED C-17, Site-3, Meerut Road Industrial Area, Ghaziabad-201003, Uttar Pradesh-201003, India</b>		
<b>Date of Registration</b>	27/01/2023	
<b>Title</b>	AIR COOLER	
<b>Priority NA</b>		
<b>Design Number</b>	378073-001	
<b>Class</b>	15-05	
<b>1.K. Ramakrishnan College of Engineering NH-45, Samayapuram, Trichy - 621 112, Tamil Nadu, India 2. Dr. D. Srinivasan Principal &amp; Professor, K. Ramakrishnan College of Engineering, Trichy, Tamil Nadu, India - 621112 3. Mr. P. Ragul UG Student, Mechanical Engineering, K. Ramakrishnan College of Engineering, Trichy, Tamil Nadu, India - 621112</b>		
<b>Date of Registration</b>	27/01/2023	
<b>Title</b>	CEILING FAN CLEANER	
<b>Priority NA</b>		
<b>Design Number</b>	379863-001	
<b>Class</b>	10-04	
<b>1.Vallurupalli Nageswara Rao Vignana Jyothi Institute of Engineering and Technology Vignana Jyothi Nagar, Pragathi Nagar,Nizampet (S.O), Hyderabad 500 090, Telangana, India 2. Dr. Suresh Kommu VNRVJIET, Hyderabad 500090, Telangana</b>		
<b>Date of Registration</b>	22/02/2023	
<b>Title</b>	DIGITAL SOIL SENSOR	
<b>Priority NA</b>		

<b>Design Number</b>	378624-001		
<b>Class</b>	23-01		
<b>UNIFLOW CONTROLS PRIVATE LIMITED Q 49/149, JAI MATA DI COMPOUND, THANE- BHIWANDI AGRA ROAD, KALHER VILLAGE, BHIWANDI, DIST. THANE-421302, MAHARASHTRA, INDIA</b>			
<b>Date of Registration</b>	03/02/2023		
<b>Title</b>	BELLOW SEALED GLOBE CONTROL VALVE		
<b>Priority NA</b>			
<b>Design Number</b>	374123-001		
<b>Class</b>	07-01		
<b>AMAAN TAHIR THANA GALSHAEID, MORADABAD, UP-244001</b>			
<b>Date of Registration</b>	15/11/2022		
<b>Title</b>	CUP		
<b>Priority NA</b>			
<b>Design Number</b>	359886-001		
<b>Class</b>	24-04		
<b>FISHER &amp; PAYKEL HEALTHCARE LIMITED 15 Maurice Paykel Place, East Tamaki, Auckland 2013, New Zealand</b>			
<b>Date of Registration</b>	04/03/2022		
<b>Title</b>	MASK CUSHION FOR A NASAL INTERFACE		
<b>Priority</b>			
<b>Priority Number</b>	<b>Date</b>	<b>Country</b>	
29/806,884	07/09/2021	U.S.A.	

<b>Design Number</b>	379865-001		
<b>Class</b>	09-01		
<b>Pankaj Kumar Shasini Duplex – 8, OMM Palace, Panchagaon, Padhan Sahi on the road to Jatni, Jatni, Odisha 752050</b>			
<b>Date of Registration</b>	22/02/2023		
<b>Title</b>	PERFUME BOTTLE		
<b>Priority NA</b>			
<b>Design Number</b>	340729-001		
<b>Class</b>	28-03		
<b>Dorco Co., Ltd. 36-9, Hyoryeong-ro 70-gil, Seocho-gu, Seoul 06723, Republic of Korea</b>			
<b>Date of Registration</b>	15/03/2021		
<b>Title</b>	RAZOR CARTRIDGE		
<b>Priority</b>			
<b>Priority Number</b>	<b>Date</b>	<b>Country</b>	
30-2021-0002109	14/01/2021	Republic of Korea	
<b>Design Number</b>	335744-001		
<b>Class</b>	07-02		
<b>SHIVKUMAR SHANKARLAL PATEL Shed No-36, G.I.D.C. Ind.Zone,, Nr.Hindustan Marbles, Odhav, Ahmedabad, Gujarat, 382415</b>			
<b>Date of Registration</b>	01/12/2020		
<b>Title</b>	CONTAINER BOX		
<b>Priority NA</b>			

<b>Design Number</b>	378727-001	
<b>Class</b>	11-01	
<b>SABYASACHI CALCUTTA LLP 80/2 Topsia Road (South), Kolkata-700046, West Bengal.</b>		
<b>Date of Registration</b>	06/02/2023	
<b>Title</b>	JEWELLERY (SET)	
<b>Priority NA</b>		
<b>Design Number</b>	340276-001	
<b>Class</b>	15-99	
<b>Atlas Copco (India) Ltd. Sveanagar, Dapodi, Pune - 411 012, Maharashtra, India</b>		
<b>Date of Registration</b>	06/03/2021	
<b>Title</b>	CNG Engine Driven Package	
<b>Priority NA</b>		
<b>Design Number</b>	370255-001	
<b>Class</b>	10-05	
<b>1. Dr. Venkata Harshavardhan Reddy Dornadula Professor-R&amp;D, Placement &amp; Soft Skill Training, Department of H&amp;S, Sree Venkateswara College of Engineering, North Rajupalem, Kodavaluru, Nellore District- Andhra Pradesh, PIN Code - 524316 2. Dr. Hanumantharaju K N Assistant Professor, Department of Food Technology, University - Faculty of Life and Allied Health Sciences, Ramaiah University of Applied Sciences, Bengaluru-54 3. Dr Manisha Associate Professor and Head of the Department, Department of Botany, Chinmaya Degree College, BHEL, Haridwar. Affiliated to H.N.B.Garhwal University, Srinagar, Garhwal, Uttarakhand 4. Mohit Tiwari Assistant Professor, Department of Computer Science and Engineering, Bharati Vidyapeeth's College of Engineering</b>		
<b>Date of Registration</b>	02/09/2022	
<b>Title</b>	DEVICE TO DETECT RESIDUE ON PLANT	
<b>Priority NA</b>		



<b>Design Number</b>	374980-001	
<b>Class</b>	10-02	
<b>SHENZHEN LINWEAR INNOVATION TECHNOLOGY CO. , LTD 301, Building 7, No.69 Guanlan Avenue, Xikeng Community, Fucheng Street, Longhua, Shenzhen, China</b>		
<b>Date of Registration</b>	02/12/2022	
<b>Title</b>	Watch	
<b>Priority NA</b>		

<b>Design Number</b>	378792-001	
<b>Class</b>	11-01	
<b>SABYASACHI CALCUTTA LLP 80/2 Topsia Road (South), Kolkata-700046, West Bengal.</b>		
<b>Date of Registration</b>	06/02/2023	
<b>Title</b>	JEWELLERY	
<b>Priority NA</b>		

<b>Design Number</b>	334602-001	
<b>Class</b>	12-16	
<b>International Tractors Limited Pankaj Plaza 1, Plot no. 2, Commercial Complex, Karkardooma, New Delhi 110 092</b>		
<b>Date of Registration</b>	24/10/2020	
<b>Title</b>	Cooling fan for engine radiator in tractor	
<b>Priority NA</b>		

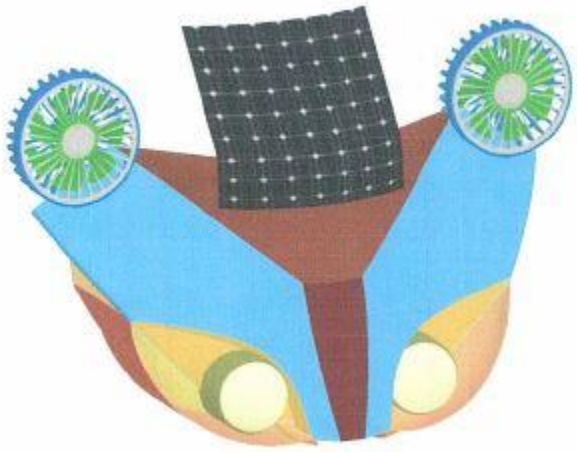
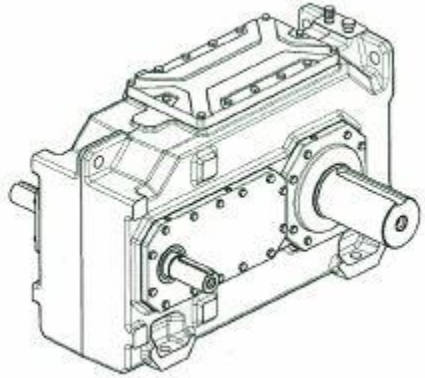

<b>Design Number</b>	324567-001		
<b>Class</b>	10-02		
<b>Shaze Luxury Retail Pvt. Ltd. 4th floor, Harchandrai House, 81 Maharshi Karve Road, Marine Lines, Mumbai 400 002</b>			
<b>Date of Registration</b>	10/12/2019		
<b>Title</b>	WATCH		
<b>Priority NA</b>			
<b>Design Number</b>	378247-001		
<b>Class</b>	10-02		
<b>SHENZHEN DO INTELLIGENT TECHNOLOGY CO., LTD. 11TH FLOOR, 3# BUILDING, CHANGYI TECH PARK, NO. 1 LIRONG ROAD, XINSHI COMMUNITY, DALANG STREET, LONGHUA DISTRICT, SHENZHEN, GUANGDONG 518000, CHINA</b>			
<b>Date of Registration</b>	30/01/2023		
<b>Title</b>	Smartwatch		
<b>Priority</b>			
<b>Priority Number</b>	<b>Date</b>	<b>Country</b>	
202230771312.8	18/11/2022	China	
<b>Design Number</b>	379579-001		
<b>Class</b>	28-03		
<b>AYUKARMA WELLNESS PRIVATE LIMITED 228, 2nd Floor, Neha Industrial Estate, Off Western Express Highway, Dattapada Road, Borivali (E), Mumbai 400 066, Maharashtra</b>			
<b>Date of Registration</b>	17/02/2023		
<b>Title</b>	Bliss Spa		
<b>Priority NA</b>			

<b>Design Number</b>	376559-001		
<b>Class</b>	12-11		
<b>1. Dr. P. Mohana Scientist C, Centre for Remote Sensing and Geoinformatics, Sathyabama Institute of Science and Technology, Jeppiaar Nagar, Rajiv Gandhi Road, Chennai - 600 119, Tamil Nadu, India</b> <b>2. Dr. B. Prabhu Dass Batvari Scientist C, Centre for Earth &amp; Atmospheric Sciences, Sathyabama Institute of Science and Technology, Jeppiaar Nagar, Rajiv Gandhi Road, Chennai - 600 119, Tamil Nadu, India</b>			
<b>Date of Registration</b>	02/01/2023		
<b>Title</b>	MOTOR CYCLE HEAD LIGHT ASSEMBLY WITH DUAL CONVENTIONAL POWERED MOBILE PHONE CHARGER		
<b>Priority NA</b>			
<b>Design Number</b>	375540-002		
<b>Class</b>	12-16		
<b>FLENDER GmbH FLENDER GmbH, ALFRED-FLENDER-STRASSE 77, DE-46395 BOCHOLT, GERMANY</b>			
<b>Date of Registration</b>	13/12/2022		
<b>Title</b>	GEAR BOX		
<b>Priority</b>			
<b>Priority Number</b>	<b>Date</b>	<b>Country</b>	
009062136	15/06/2022	EUIPO	
<b>Design Number</b>	352473-001		
<b>Class</b>	13-01		
<b>SHRIKANT SHINDE PLOT NO 35/36, NEAR NMMCE SCHOOL, SECTOR 2A, KOPARKHAIRNE, NAVI MUMBAI 400709</b>			
<b>Date of Registration</b>	01/11/2021		
<b>Title</b>	ELECTRIC DRIVE TRAIN WITH OUTER RUN MOTOR AND TRACTION DRIVE SYSTEM		
<b>Priority NA</b>			

<b>Design Number</b>	323154-001	
<b>Class</b>	15-03	
<b>CNH Industrial (India) Private Limited Plot No. 14A, 3rd floor, Sector-18, Udyog Vihar, Gurgaon-122015, Haryana, India</b>		
<b>Date of Registration</b>	31/10/2019	
<b>Title</b>	MODULAR MAIN FRAME FOR SUGARCANE HARVESTER	
<b>Priority</b>		
Priority Number	Date	Country
BR 30 2019 002195 1	23/05/2019	Brazil

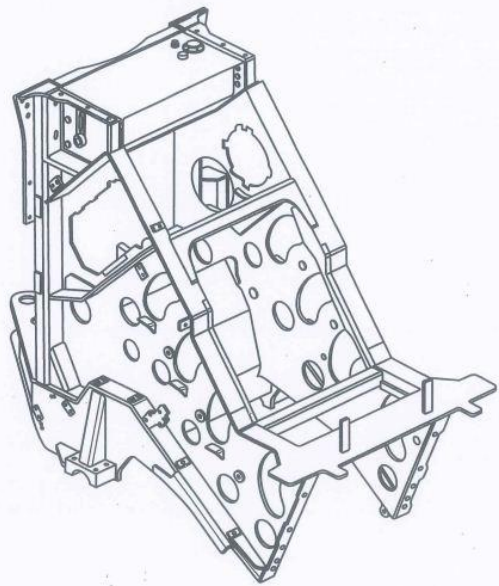

<b>Design Number</b>	378654-001	
<b>Class</b>	13-04	
<b>1. Dr. MUNESH CHANDRA TRIVEDI ASSOCIATE PROFESSOR, DEPT OF CSE, NIT AGARTALA 799046 WEST TRIPURA. TRIPURA 2. Ms. NANDITA GOYAL ASSISTANT PROFESSOR, DEPT OF IT, AJAY KUMAR GARG ENGINEERING COLLEGE, GHAZIABAD 201002 3. Dr. MRINAL KANTI DEB BARMA ASSOCIATE PROFESSOR, DEPT OF CSE, NIT AGARTALA 799046 WEST TRIPURA, TRIPURA 4. Mr. PRASHANT BHARDWAJ ASSISTANT PROFESSOR, DEPT OF CSE NIT AGARTALA 799046, WEST TRIPURA, TRIPURA</b>		
<b>Date of Registration</b>	04/02/2023	
<b>Title</b>	Smart stand for sun tracking solar panel	
<b>Priority NA</b>		

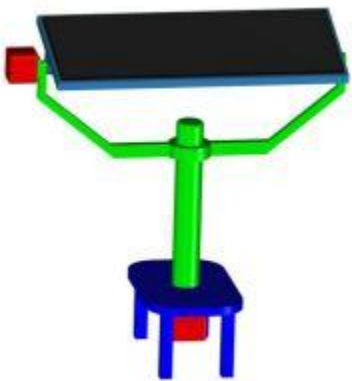

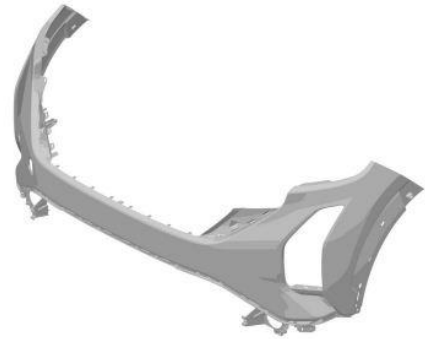

<b>Design Number</b>	361967-001	
<b>Class</b>	12-16	
<b>Ford Global Technologies, LLC 330 Town Center Drive, Suite 800, Dearborn Michigan, 48126, United States of America</b>		
<b>Date of Registration</b>	05/04/2022	
<b>Title</b>	Front Upper Bumper Cover	
<b>Priority</b>		
Priority Number	Date	Country
402021100966.3	20/10/2021	Germany

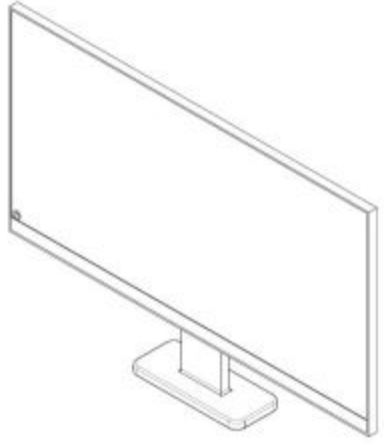

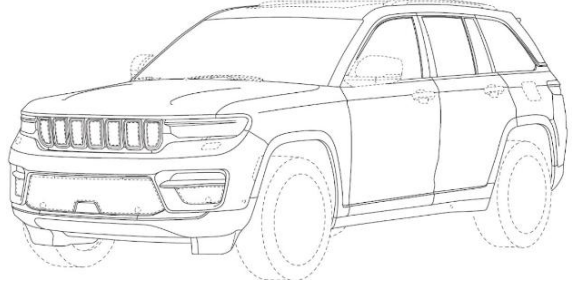

<b>Design Number</b>	378733-001	
<b>Class</b>	14-03	
<b>Mr. Dharam Pal E-2 Jeevan Park, Ground floor, Pankha Road, Uttam Nagar, New Delhi, Pin Code- 110059, India</b>		
<b>Date of Registration</b>	06/02/2023	
<b>Title</b>	Smart Television with Removable Stand	
<b>Priority NA</b>		

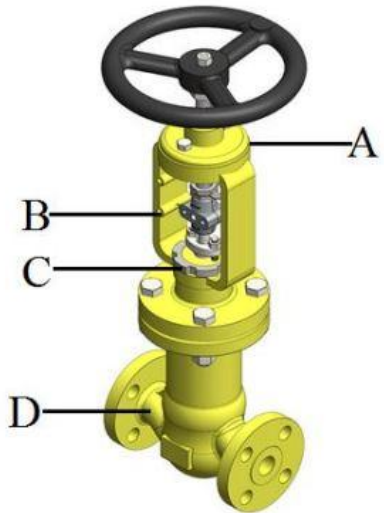
<b>Design Number</b>	345613-001	
<b>Class</b>	12-08	
<b>FCA US LLC 1000 Chrysler Drive, Auburn Hills, Michigan 48326, United States of America</b>		
<b>Date of Registration</b>	02/07/2021	
<b>Title</b>	AUTOMOBILE EXTERIOR	
<b>Priority</b>		
<b>Priority Number</b>	<b>Date</b>	<b>Country</b>
29/764, 840	04/01/2021	U.S.A.

<b>Design Number</b>	359704-001	
<b>Class</b>	23-04	
<b>Havells India Limited 904, 9th Floor, Surya Kiran Building, K G Marg, Connaught Place, New Delhi -110001</b>		
<b>Date of Registration</b>	02/03/2022	
<b>Title</b>	CEILING FAN	
<b>Priority NA</b>		

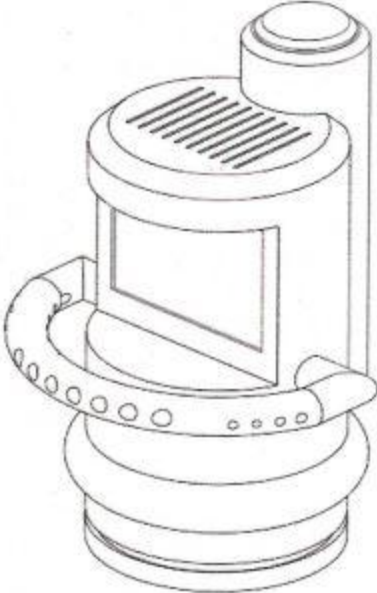

<b>Design Number</b>	378623-001	
<b>Class</b>	23-01	
<b>UNIFLOW CONTROLS PRIVATE LIMITED Q 49/149, JAI MATA DI COMPOUND, THANE- BHIWANDI AGRA ROAD, KALHER VILLAGE, BHIWANDI, DIST. THANE-421302, MAHARASHTRA, INDIA</b>		
<b>Date of Registration</b>	03/02/2023	
<b>Title</b>	MANUAL BELLOWS SEALED GLOBE CONTROL VALVE	
<b>Priority NA</b>		
<b>Design Number</b>	380476-001	
<b>Class</b>	02-05	
<b>SABYASACHI CALCUTTA LLP 80/2 Topsia Road (South), Kolkata-700046, West Bengal.</b>		
<b>Date of Registration</b>	28/02/2023	
<b>Title</b>	SHAWL	
<b>Priority NA</b>		
<b>Design Number</b>	349558-001	
<b>Class</b>	02-02	
<b>Brijwasi Developers Private Limited 102, Platinum apartment, Brijwasi Estate, Near gateway Hotel, Parle Point, Surat., Surat, Gujarat, 395010.</b>		
<b>Date of Registration</b>	16/09/2021	
<b>Title</b>	Ladies Dress Set	
<b>Priority NA</b>		

<b>Design Number</b>	325794-001		
<b>Class</b>	12-16		
<b>M/S. WHEELS INDIA LTD MTH ROAD, PADI, CHENNAI, TAMIL NADU-600050, INDIA</b>			
<b>Date of Registration</b>	10/01/2020		
<b>Title</b>	WHEEL RIM WITH EYE SHAPED VENT HOLES		
<b>Priority NA</b>			
<b>Design Number</b>	328484-001		
<b>Class</b>	26-03		
<b>Kohler Co., 444 Highland Drive, Kohler, WI 53044, United States of America</b>			
<b>Date of Registration</b>	20/03/2020		
<b>Title</b>	LIGHT FIXTURE		
<b>Priority</b>			
<b>Priority Number</b>	<b>Date</b>	<b>Country</b>	
29/706,622	21/09/2019	U.S.A.	
<b>Design Number</b>	375198-008		
<b>Class</b>	11-01		
<b>Aulyra Design Private Limited 3rd floor, Plot No. 3807, Phase 4, Chakkarpur, Gurugram, Haryana – 122001</b>			
<b>Date of Registration</b>	07/12/2022		
<b>Title</b>	Wristwear		
<b>Priority NA</b>			

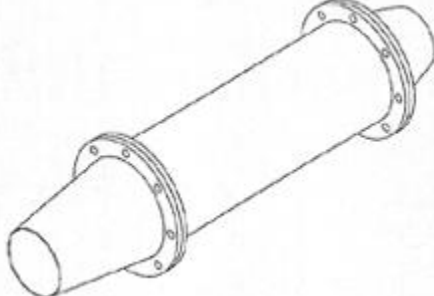
Design Number	378947-001	
Class	24-01	
<p>1. Dr. Yogini Dilip Borole G H Raisoni College of Engineering and Management, Wagholi, Pune, Maharashtra - 412207</p> <p>2. Mr. Sudhir Gopalrao Hate G H Raisoni College of Engineering and Management, Gat no 1200, Domkhel road, Wagholi, Pune, Maharashtra - 412207</p> <p>3. Dr. R. D. Kharadkar G H Raisoni College of Engineering and Management, Wagholi, Pune, Maharashtra - 412207</p> <p>4. G H Raisoni College of Engineering and Management G H Raisoni College of Engineering and Management, Wagholi, Pune, Maharashtra - 412207</p>		
Date of Registration	08/02/2023	
Title	IOT based robot for germicide sprayer	
Priority NA		

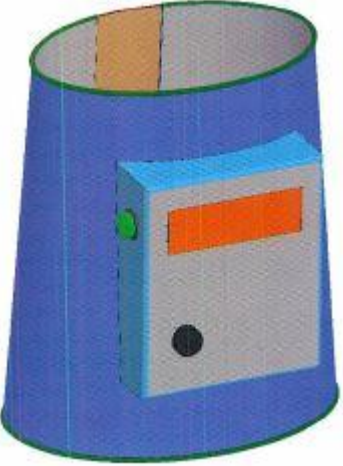
Design Number	342997-001	
Class	15-01	
<p>1. Mr. M. Kesavan Assistant Professor, Department of Aeronautical Engineering, Nehru Institute of Engineering and Technology, Coimbatore - 641 105, Tamilnadu, India</p> <p>2. Mr. R. Kousik Kumaar Assistant Professor, Department of Aeronautical Engineering, Nehru Institute of Engineering and Technology, Coimbatore - 641 105, Tamilnadu, India</p> <p>3. Mrs. T. Muthumari Assistant Professor, Department of Aeronautical Engineering, Nehru Institute of Engineering and Technology, Coimbatore - 641 105, Tamilnadu, India</p> <p>4. Dr. R. Ramaswamy Associate Professor, Department of Aeronautical Engineering, Nehru Institute of Engineering and Technology, Coimbatore - 641 105, Tamilnadu, India</p>		
Date of Registration	03/05/2021	
Title	FLYING THERMODYNAMIC DUCT	
Priority NA		

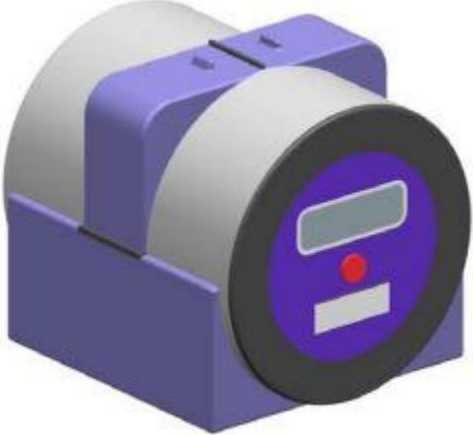
Design Number	378048-001	
Class	02-07	
<p>1. KIT-KalaignarKarunanidhi Institute of Technology Kannampalayam Post, Coimbatore - 641 402, Tamilnadu, India</p> <p>2. Dr. C. Deepa Associate Professor, Department of Artificial Intelligence &amp; Data Science, KIT-KalaignarKarunanidhi Institute of Technology, Kannampalayam Post, Coimbatore - 641 402, Tamilnadu, India</p> <p>3. Dr. S. Rajamohamed Professor, Department of CSE, KIT-KalaignarKarunanidhi Institute of Technology, Kannampalayam Post, Coimbatore - 641 402, Tamilnadu, India</p> <p>4. R. Thamizharasan Assistant Professor, Department of EEE, KIT-KalaignarKarunanidhi Institute of Technology, Kannampalayam Post, Coimbatore - 641 402, Tamilnadu, India , et al.</p>		
Date of Registration	27/01/2023	
Title	WRISTBAND WITH LOCATION TRACKER	
Priority NA		

Design Number	359717-001	
Class	23-04	
<b>HAVELLS INDIA LIMITED 904, 9th Floor, Surya Kiran Building, K.G. Marg, Connaught Place, New Delhi-110001, India</b>		
Date of Registration	02/03/2022	
Title	AIR CONDITIONER	
Priority NA		
Design Number	378912-001	
Class	03-01	
<b>1. Prof. (Dr.) SAILESH KUMAR GHATUARY Principal cum Director, Shri RLT Institute of Pharmaceutical Science &amp; Technology, Eakdil, ETAWAH, Uttar Pradesh- 206126, India 2. Dr. Shobharam Sahu Rajiv Gandhi College of Pharmacy, Nautanwa, Maharajganj, Uttar Pradesh- 273164, India 3. Dr. Ashutosh Kumar Yadav Tirupati College of Engineering Lucknow, 99/100, Hans Nagar Colony Para, Lucknow, Uttar Pradesh- 226301, India 4. Dr. Anil Sarathe Vaishnavi Institute of Pharmacy, Raisen, L-1, Daisy, Spring Valley, Katara Hills, Bhopal, Madhya Pradesh- 462043, India , et al.</b>		
Date of Registration	08/02/2023	
Title	DEVICE FOR DISPENSING TABLETS	
Priority NA		
Design Number	378703-001	
Class	28-03	
<b>1. Dr. Sameer Chauhan K.M Shah Dental College and Hospital Sumandeep Vidyapeeth An Institution Deemed to be University, Piparia, Vadodara, Gujarat 2. Dr. Paranjay Prajapati K.M Shah Dental College and Hospital Sumandeep Vidyapeeth An Institution Deemed to be University, Piparia, Vadodara, Gujarat 3. Dr. Yash Shah K.M Shah Dental College and Hospital Sumandeep Vidyapeeth An Institution Deemed to be University, Piparia, Vadodara, Gujarat 4. Dr. Pratik Kariya K.M Shah Dental College and Hospital Sumandeep Vidyapeeth An Institution Deemed to be University, Piparia, Vadodara, Gujarat</b>		
Date of Registration	06/02/2023	
Title	Easy Clean Tongue Cleaner	
Priority NA		



<b>Design Number</b>	359237-001	
<b>Class</b>	11-01	
<b>Louis Vuitton Malletier 2 rue du Pont-Neuf, 75001 Paris, France</b>		
<b>Date of Registration</b>	24/02/2022	
<b>Title</b>	Finger ring	
<b>Priority</b>		
Priority Number	Date	Country
20213905	31/08/2021	France

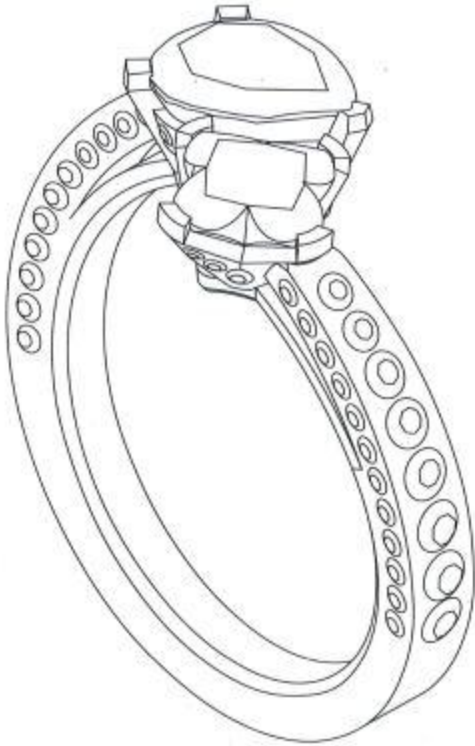

<b>Design Number</b>	342236-001	
<b>Class</b>	09-07	
<b>Bayer Consumer Care AG Peter Merian-Str. 84, 4052 Basel, CH-Switzerland</b>		
<b>Date of Registration</b>	09/04/2021	
<b>Title</b>	Pump without Tamper Evidence	
<b>Priority</b>		
Priority Number	Date	Country
008331797	17/12/2020	EUIPO



<b>Design Number</b>	377376-001	
<b>Class</b>	08-01	
1. Dr. J. Chandradass Associate Professor, Centre for Automotive Materials Department of Automobile Engineering SRM Institute of Science and Technology Kattankulathur, Chengalpattu Pin code: 603 203, Tamilnadu, India 2. Dr. R. Mariappan Assistant Professor, Department of Physics Saranathan College of Engineering Panjappur, Trichy, Pin code: 620 012, Tamilnadu, India 3. Mr. T. Thirugnanasambandham Research Scholar, Department of Mechanical Engineering, PRIST Deemed University Vallam, Thanjavur Pin code: 613 403, Tamilnadu, India		
<b>Date of Registration</b>	13/01/2023	
<b>Title</b>	ECCENTRIC DRILL JIG AND FIXTURE SETUP	
<b>Priority NA</b>		

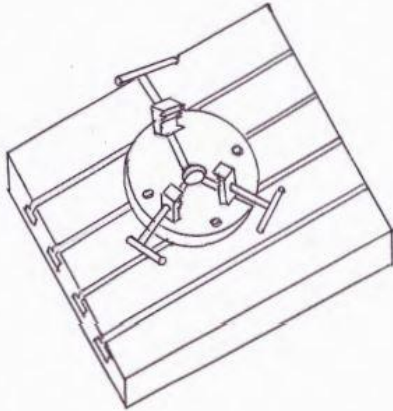

<b>Design Number</b>	361079-001	
<b>Class</b>	25-01	
<b>1. TOMOEGAVA CO., LTD. 2-1-3, Kyobashi, Chuo-ku, Tokyo 104-8335, Japan 2. YOSHINO GYPSUM CO., LTD. Shin-Tokyo Bldg., 3-3-1, Marunouchi, Chiyoda-ku, Tokyo 100-0005, Japan</b>		
<b>Date of Registration</b>	23/03/2022	
<b>Title</b>	JOINT MATERIAL WITH ADHESIVE	
<b>Priority</b>		
Priority Number	Date	Country
2021-022285	13/10/2021	Japan

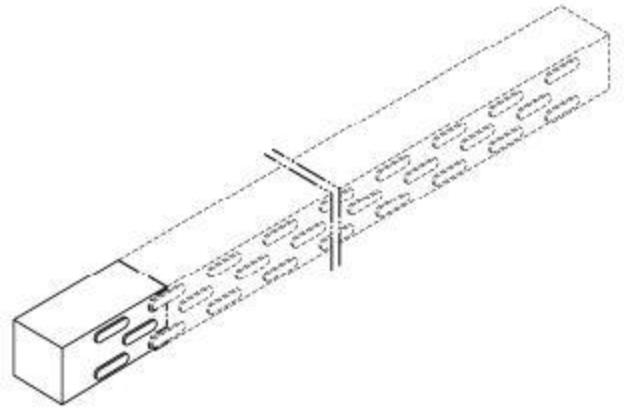





<b>Design Number</b>	339188-002	
<b>Class</b>	02-02	
<b>Reflect Sculpt Pvt. Ltd. A-42, Sector-5, Noida, U.P., India</b>		
<b>Date of Registration</b>	16/02/2021	
<b>Title</b>	GOWN	
<b>Priority NA</b>		



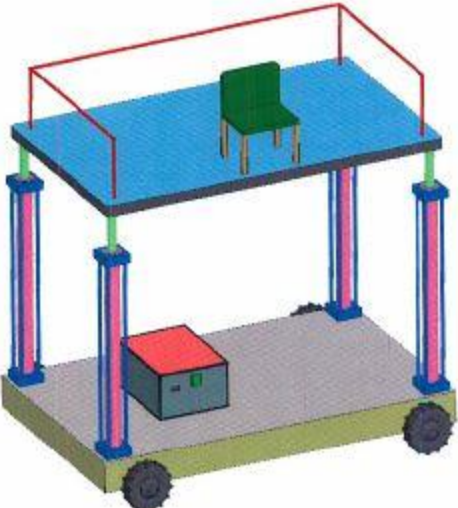

<b>Design Number</b>	378895-001	
<b>Class</b>	13-03	
<b>HASUBHAI CHHAGANBHAI VALIYA Ground Floor, 84, Opp Bhikshuk Gruh, Road Number 1 Odhav, Ahmedabad, Gujarat,382415</b>		
<b>Date of Registration</b>	08/02/2023	
<b>Title</b>	Industrial Plug & Sockets	
<b>Priority NA</b>		

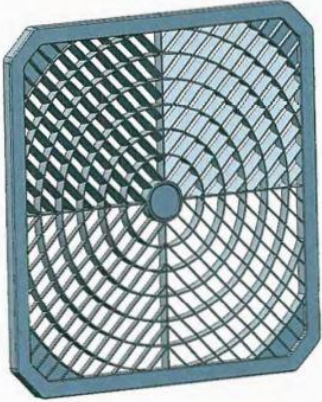

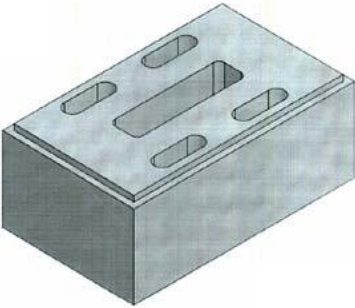
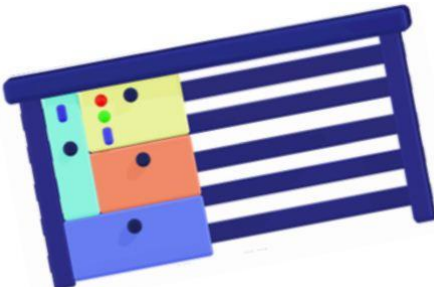

Design Number	368948-001	
Class	12-02	
<p>1. Daruwala Fuzail Gandhinagar Institute of Technology, Khatraj-Kalol Road, Moti Bhojan, Gandhinagar district, Kalol - 382721, Gujarat, INDIA 2. Akhunji Mohammed Bilal Gandhinagar Institute of Technology, Khatraj-Kalol Road, Moti Bhojan, Gandhinagar district, Kalol - 382721, Gujarat, INDIA 3. Miraz Mohammed Azim Gandhinagar Institute of Technology, Khatraj-Kalol Road, Moti Bhojan, Gandhinagar district, Kalol - 382721, Gujarat, INDIA 4. Dr Hetal N Shah Gandhinagar Institute of Technology, Khatraj-Kalol Road, Moti Bhojan, Gandhinagar district, Kalol - 382721, Gujarat, INDIA , et al.</p>		
Date of Registration	09/08/2022	
Title	STAIR CLIMBING TROLLEY	
Priority NA		
Design Number	378050-002	
Class	12-05	
<p>1. KIT-KalaighnarKarunanidhi Institute of Technology Kannampalayam Post, Coimbatore - 641 402, Tamilnadu, India 2. D. Ashok Kumar Assistant Professor, Department of Mechanical Engineering, KIT-KalaighnarKarunanidhi Institute of Technology, Kannampalayam Post, Coimbatore - 641 402, Tamilnadu, India 3. K. Sathish Kumar Assistant Professor, Department of Mechanical Engineering, KIT-KalaighnarKarunanidhi Institute of Technology, Kannampalayam Post, Coimbatore - 641 402, Tamilnadu, India 4. Dr. THA. Thayumanavan Associate Professor., Biotechnology, KIT-KalaighnarKarunanidhi Institute of Technology, Kannampalayam Post, Coimbatore - 641 402, Tamilnadu, India , et al.</p>		
Date of Registration	27/01/2023	
Title	PORTABLE TELESCOPIC LIFT FOR AUTOMOBILE INDUSTRY	
Priority NA		
Design Number	349246-001	
Class	23-01	
Ranjeeta Jain 38 Dharamkunj, Sector - 9, Rohini, Delhi -110085, India		
Date of Registration	09/09/2021	
Title	Encapsulated receptacle for Planter,	
Priority NA		

<b>Design Number</b>	378991-001	
<b>Class</b>	24-01	
<b>Rajesh Suhas Swami Department of Prosthodontics, KLE VK Institute of Dental Sciences and Hospital, J.N. Medical College Campus, Nehru nagar, Belagavi-590010</b>		
<b>Date of Registration</b>	09/02/2023	
<b>Title</b>	DENTAL WAX SPOON	
Priority NA		
<b>Design Number</b>	377364-002	
<b>Class</b>	23-04	
<b>M/S Ecco Cool Home Appliances House No. 56, Shani Gate, Maliwara, Ghaziabad, Uttarpradesh-201001, India, Partners are Pradeep Kumar, Manjeet Singh</b>		
<b>Date of Registration</b>	13/01/2023	
<b>Title</b>	COOLER GRILL	
Priority NA		
<b>Design Number</b>	378706-001	
<b>Class</b>	15-03	
<b>Jangeer Manufacturing Industries Private Limited Near New Dhan Mandi, Anoopgarh Road, Raisinghnagar, (Distt. Sri Ganganagar) Rajasthan.</b>		
<b>Date of Registration</b>	06/02/2023	
<b>Title</b>	THRESHER PARTS	
Priority NA		

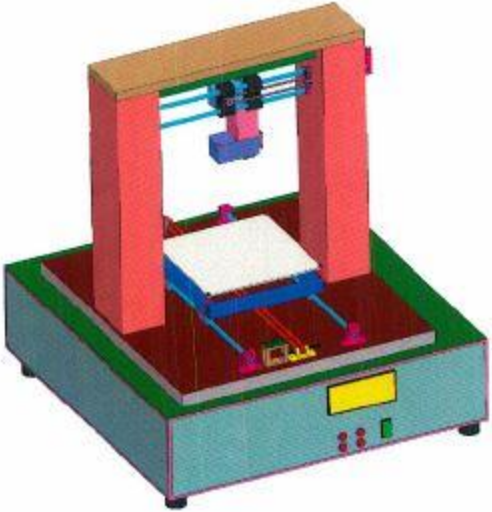
<b>Design Number</b>	363933-001	
<b>Class</b>	25-01	
<b>1.A.Mohan Assistant professor, Department of Civil Engineering, Easwari Engineering College, Bharathi salai Ramapuram, Chennai 2. Dr. Saravanan. J Associate Professor, Department of Civil &amp;Structural Engineering, Faculty of Engineering &amp; Technology Annamalai University, Annamalai nagar - 608002 Cuddalore District, Tamilnadu.</b>		
<b>Date of Registration</b>	09/05/2022	
<b>Title</b>	CONSTRUCTION AND DEMOLITION WASTE GEOPOLYMER BRICK	
<b>Priority NA</b>		
<b>Design Number</b>	361335-001	
<b>Class</b>	06-03	
<b>1. CHITKARA UNIVERSITY (PUNJAB) CHITKARA UNIVERSITY, CHANDIGARH-PATIALA, NATIONAL HIGHWAY, VILLAGE JHANSLA, RAJPURA, PUNJAB - 140401, INDIA. 2. CHITKARA INNOVATION INCUBATOR FOUNDATION SCO: 160-161, SECTOR -9C, MADHYA MARG, CHANDIGARH- 160009, INDIA. 3. SHILPI HARNAL CHITKARA UNIVERSITY INSTITUTE OF ENGINEERING AND TECHNOLOGY CHITKARA UNIVERSITY, PUNJAB - 135001, INDIA. 4. GAURAV SHARMA 1675/8, VISHNU COLONY KURUKSHETRA-136118, INDIA. , et al.</b>		
<b>Date of Registration</b>	28/03/2022	
<b>Title</b>	MULTIPURPOSE TABLE WITH COOLING AND HEATING SYSTEM	
<b>Priority NA</b>		
<b>Design Number</b>	376223-001	
<b>Class</b>	14-06	
<b>1.SIMATS SCHOOL OF ENGINEERING SIMATS SCHOOL OF ENGINEERING, SAVEETHA NAGAR, THANDALAM, CHENNAI-602105, TAMILNADU, INDIA 2. SASIDARAN T N SASIDARAN T N, DEPARTMENT OF COMPUTER SCIENCE AND ENGINEERING, SIMATS SCHOOL OF ENGINEERING, SAVEETHA NAGAR, THANDALAM, CHENNAI-602105, TAMILNADU, INDIA 3. DR S SRINIVASAN DR S SRINIVASAN, DEPARTMENT OF BIOMEDICAL ENGINEERING, SIMATS SCHOOL OF ENGINEERING, SAVEETHA NAGAR, THANDALAM, CHENNAI-602105, TAMILNADU, INDIA 4. DR DEEPAK NALLASWAMY V DR DEEPAK NALLASWAMY V, DEPARTMENT OF PROSTHODONTICS, SAVEETHA DENTAL COLLEGE AND HOSPITAL, NO 162, POONAMALLEE HIGH ROAD, VELAPPANCHAVADI, CHENNAI-600077, TAMILNADU, INDIA , et al.</b>		
<b>Date of Registration</b>	27/12/2022	
<b>Title</b>	SMART MULTI-PURPOSE LAPTOP STAND	
<b>Priority NA</b>		

<b>Design Number</b>	376446-001	
<b>Class</b>	15-09	
<b>1.DR N PALANIVEL ASSOCIATE PROFESSOR, DEPARTMENT OF COMPUTER SCIENCE AND ENGINEERING, MANAKULA VINAYAGAR INSTITUTE OF TECHNOLOGY, KALITHEERTHALKUPPAM, PUDUCHERRY-605107, INDIA 2. R RAJBHARATH ASSISTANT PROFESSOR, DEPARTMENT OF COMPUTER SCIENCE AND ENGINEERING, MANAKULA VINAYAGAR INSTITUTE OF TECHNOLOGY, KALITHEERTHALKUPPAM, PUDUCHERRY-605107, INDIA</b>		
<b>Date of Registration</b>	30/12/2022	
<b>Title</b>	3D CREAM PRINTER FOR CAKE	
<b>Priority NA</b>		

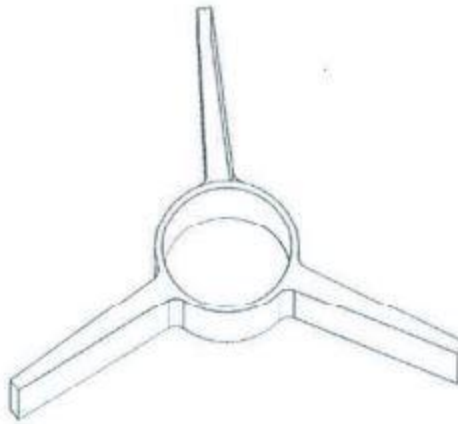

<b>Design Number</b>	379363-001	
<b>Class</b>	09-02	
<b>RUPALBEN RAMESHBHAI JAVIYA CITY PRIDE COMPLEX BASEMENT, MITHAKHALI - 6TH ROAD CIRCLE, AHMEDABAD - 380009 (GUJARAT)</b>		
<b>Date of Registration</b>	15/02/2023	
<b>Title</b>	CAN	
<b>Priority NA</b>		

<b>Design Number</b>	348433-001	
<b>Class</b>	12-11	
<b>SG Corporate Mobility Private Limited Electronic city, Udhyog Vihar, Phase IV, Sector-18, Gurgaon, Haryana-122015</b>		
<b>Date of Registration</b>	26/08/2021	
<b>Title</b>	Detel EasyPlus Red Electric Bike	
<b>Priority NA</b>		

<b>Design Number</b>	379028-001	
<b>Class</b>	23-03	
<b>INDIAN INSTITUTE OF TECHNOLOGY ROORKEE ROORKEE-247667</b>		
<b>Date of Registration</b>	09/02/2023	
<b>Title</b>	THREE LEGGED SPACER FOR DOUBLE PIPE HEAT EXCHANGER	
<b>Priority NA</b>		

<b>Design Number</b>	379734-001	
<b>Class</b>	02-02	
<b>SABYASACHI CALCUTTA LLP 80/2 Topsia Road (South), Kolkata-700046, West Bengal.</b>		
<b>Date of Registration</b>	20/02/2023	
<b>Title</b>	LADIES GARMENT (SET)	
<b>Priority NA</b>		

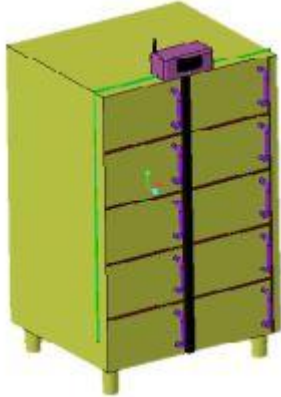
<b>Design Number</b>	379333-001	
<b>Class</b>	09-09	
<b>1.Sant Gajanan Maharaj College Of Engineering, Mahagaon Site- Chinchewadi, Gadhighlaj Hasurwadi Road, Chincewadi, Mahagaon, Gadhighlaj, Maharashtra 416503</b> <b>2. Yogesh Balasaheb Kumbhar Student, Sant Gajanan Maharaj College Of Engineering, Mahagaon, Maharashtra 416503</b> 3. Shubham Basavraj Jangali Student, Sant Gajanan Maharaj College Of Engineering, Mahagaon, Maharashtra 416503 4. Poonam Basavraj Jangali Student, Sant Gajanan Maharaj College Of Engineering, Mahagaon, Maharashtra 416503 , et al.		
<b>Date of Registration</b>	15/02/2023	
<b>Title</b>	GARBAGE LEVEL MONITORING BIN	
<b>Priority NA</b>		

Design Number	376444-001	
Class	23-99	
<b>1.DR R VALLI DR R VALLI, PROFESSOR &amp; R&amp;D COORDINATOR, DEPARTMENT OF ELECTRONICS AND COMMUNICATION ENGINEERING, MANAKULA VINAYAGAR INSTITUTE OF TECHNOLOGY, KALITHEERTHALKUPPAM, PUDUCHERRY-605107, INDIA 2. V AKSHAYA V AKSHAYA, DEPARTMENT OF ELECTRONICS AND COMMUNICATION ENGINEERING, MANAKULA VINAYAGAR INSTITUTE OF TECHNOLOGY, KALITHEERTHALKUPPAM, PUDUCHERRY-605107, INDIA 3. N BHARATHI N BHARATHI, DEPARTMENT OF ELECTRONICS AND COMMUNICATION ENGINEERING, MANAKULA VINAYAGAR INSTITUTE OF TECHNOLOGY, KALITHEERTHALKUPPAM, PUDUCHERRY-605107, INDIA 4. A ISITA A ISITA, DEPARTMENT OF ELECTRONICS AND COMMUNICATION ENGINEERING, MANAKULA VINAYAGAR INSTITUTE OF TECHNOLOGY, KALITHEERTHALKUPPAM, PUDUCHERRY-605107, INDIA , et al.</b>		
Date of Registration	30/12/2022	
Title	ELECTRICALLY OPERATED USED NAPKIN DISPOSAL MACHINE	
Priority NA		
Design Number	379414-001	
Class	06-04	
<b>1.Dr.S.SAJITHABANU ASST.PROFESSOR , MCA, MOHAMED SATHAK ENGINEERING COLLEGE , KILAKARAI , TAMILNADU -623806 2. Mr.Zameer Ahmed Adhoni Assistant Professor , Computer science and technology , Gitam School of Technology, Gitam University , Bengaluru, Karnataka -561203 3. Dr S K Niranjana Professor, Computer Applications, JSS Science and Technology University, Mysuru, Karnataka-570006 4. Mr. RAJEEV RATNA VALLABHUNI APPLICATION DEVELOPER, BAYVIEW ASSET MANAGEMENT, LLC, FLORIDA, USA , et al.</b>		
Date of Registration	16/02/2023	
Title	IOT ENABLED FILE STORAGE RACKS	
Priority NA		
Design Number	365673-001	
Class	10-02	
<b>VIAN INTERNATIONAL KHASRA NO. 1122, RITHALA, DELHI-110085, INDIA.</b>		
Date of Registration	08/06/2022	
Title	WRIST WATCH	
Priority NA		

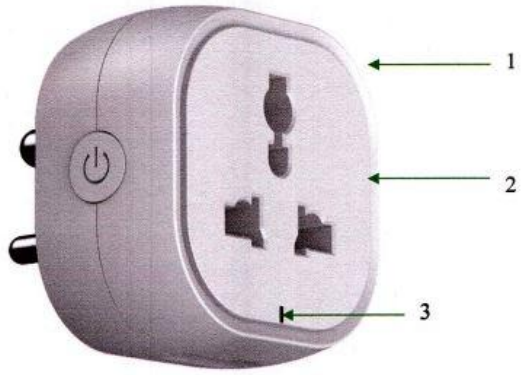

<b>Design Number</b>	379494-001	
<b>Class</b>	13-03	
<b>V-Guard Industries Ltd 42/962, Vennala High School Road, Vennala, Kochi – 682028, Kerala State</b>		
<b>Date of Registration</b>	16/02/2023	
<b>Title</b>	Smart Plug	
<b>Priority NA</b>		

<b>Design Number</b>	358824-001	
<b>Class</b>	09-03	
<b>KOKUYO CAMLIN LIMITED HILTON HOUSE, 48/2, NEAR ANDHERI MIDC POLICE STATION, ANDHERI (EAST), MUMBAI - 400 093, MAHARASHTRA, INDIA</b>		
<b>Date of Registration</b>	18/02/2022	
<b>Title</b>	Geometric Box	
<b>Priority NA</b>		

<b>Design Number</b>	376298-018	
<b>Class</b>	15-02	
<b>TOPLAND PUMPS PRIVATE LIMITED 1, UMAKANT PANDIT UDYOGNAGAR, MAVDI PLOT, RAJKOT-360004, GUJARAT</b>		
<b>Date of Registration</b>	28/12/2022	
<b>Title</b>	BASE MOTOR OF SUBMERSIBLE PUMPSET	
<b>Priority NA</b>		

<b>Design Number</b>	344355-001	
<b>Class</b>	28-03	
<b>Golakiya Maulik Narshibhai B-701, Silver Palace, Behind Astha Square, Utran, Chorasi, Surat, Gujarat - 394105, INDIA</b>		
<b>Date of Registration</b>	07/06/2021	
<b>Title</b>	Trimmer	
<b>Priority NA</b>		